

TL431U / AU

Programmable Precision Reference

Features:

- Programmable output Voltage to 36 V
- Low dynamic output impedance
- Sink current capability of 1 to 100 mA
- Low output noise voltage
- Fast turn on response

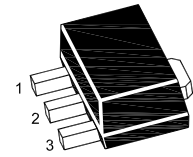

1.Reference 2.Anode 3.Cathode
SOT-89 Plastic Package

Absolute Maximum Ratings ($T_a = 25^\circ\text{C}$, unless otherwise noted.)

Parameter	Symbol	Value	Unit
Cathode Voltage	V_{KA}	37	V
Cathode Current Range (Continuous)	I_{KA}	- 100 to + 150	mA
Reference Input Current Range	I_{REF}	- 0.05 to + 10	mA
Power Dissipation	P_D	770	mW
Operating Temperature Range	T_{opr}	- 25 to + 85	$^\circ\text{C}$
Junction Temperature	T_j	150	$^\circ\text{C}$
Storage Temperature Range	T_{stg}	- 65 to + 150	$^\circ\text{C}$

Recommended Operating Conditions

Parameter	Symbol	Min.	Max.	Unit
Cathode Voltage	V_{KA}	V_{REF}	36	V
Cathode Current	I_{KA}	1	100	mA

Characteristics at $T_a = 25^\circ\text{C}$

Parameter	Symbol	Min.	Typ.	Max.	Unit
Reference Input Voltage at $V_{KA} = V_{REF}$, $I_{KA} = 10\text{ mA}$	V_{REF}	2.44 2.48	2.495 2.495	2.55 2.51	V
Deviation of Reference Input Voltage Over Temperature at $V_{KA} = V_{REF}$, $I_{KA} = 10\text{ mA}$, $- 25^\circ\text{C} \leq T_a \leq + 85^\circ\text{C}$	$\Delta V_{REF} / \Delta T$	-	4.5	17	mV
Ratio of Change in Reference Input Voltage to the Change in Cathode Voltage at $I_{KA} = 10\text{ mA}$	$\Delta V_{REF} / \Delta V_{KA}$	- -	-1.0 -0.5	-2.7 -2	mV/V
Reference Input Current at $I_{KA} = 10\text{ mA}$, $R1 = 10\text{ K}\Omega$, $R2 = \infty$	I_{REF}	-	1.5	4	μA
Deviation of Reference Input Current Over Full Temperature at $I_{KA} = 10\text{ mA}$, $R1 = 10\text{ K}\Omega$, $R2 = \infty$, $- 25^\circ\text{C} \leq T_a \leq + 85^\circ\text{C}$	$\Delta I_{REF} / \Delta T$	-	0.4	1.2	μA
Minimum Cathode Current for Regulation at $V_{KA} = V_{REF}$	$I_{KA(\text{min})}$	-	0.45	1	mA
Off-Stage Cathode Current at $V_{KA} = 36\text{ V}$, $V_{REF} = 0$	$I_{KA(\text{OFF})}$	-	0.05	1	μA
Dynamic Impedance at $V_{KA} = V_{REF}$, $I_{KA} = 1\text{ to }100\text{ mA}$, $f \leq 1\text{ KHz}$	Z_{KA}	-	0.15	0.5	Ω

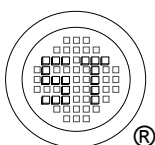

SEMTECH ELECTRONICS LTD.



Fig 1 Cathode Current Vs Cathode Voltage

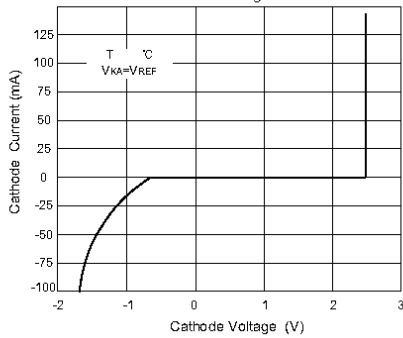

Fig 2 Cathode Current Vs Cathode Voltage

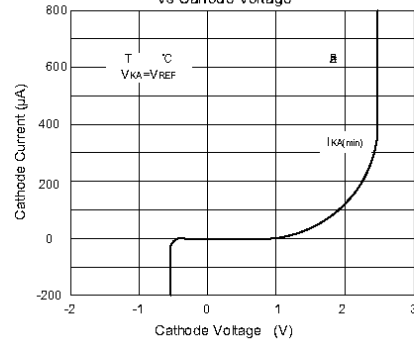

Fig 3 Change in Reference Input Voltage Vs Cathode voltage

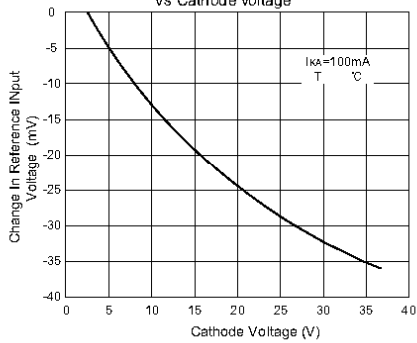

Fig 4 Pulse Response

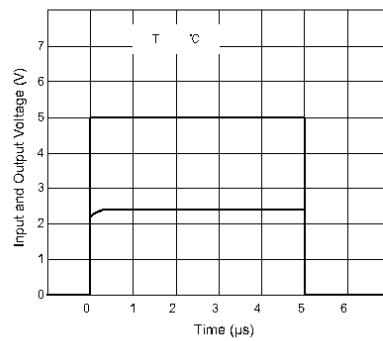

Fig 5 Dynamic Impedance Vs Frequency

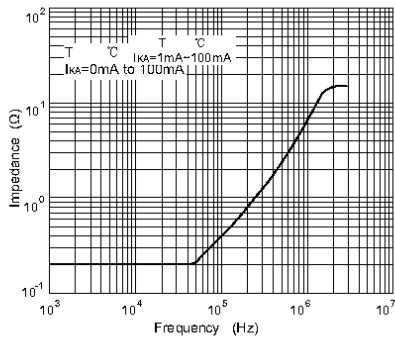
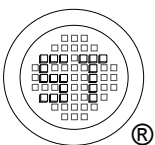
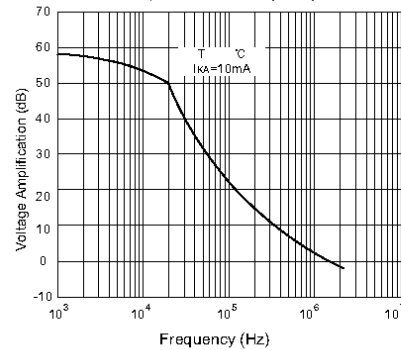

Fig 6 Small Signal Voltage Amplification Vs Frequency



SEMTECH ELECTRONICS LTD.



ISO/TS 16949 : 2009 Certificate No. 180713000 | ISO14001 : 2004 Certificate No. 7116 | ISO 9001 : 2008 Certificate No. 50719410 | BS-OHSAS 18001 : 2007 Certificate No. 7116 | IECQ QC 080000 Certificate No. PRC-HSPM-1483-1

TL431U / AU

SOT-89 PACKAGE OUTLINE

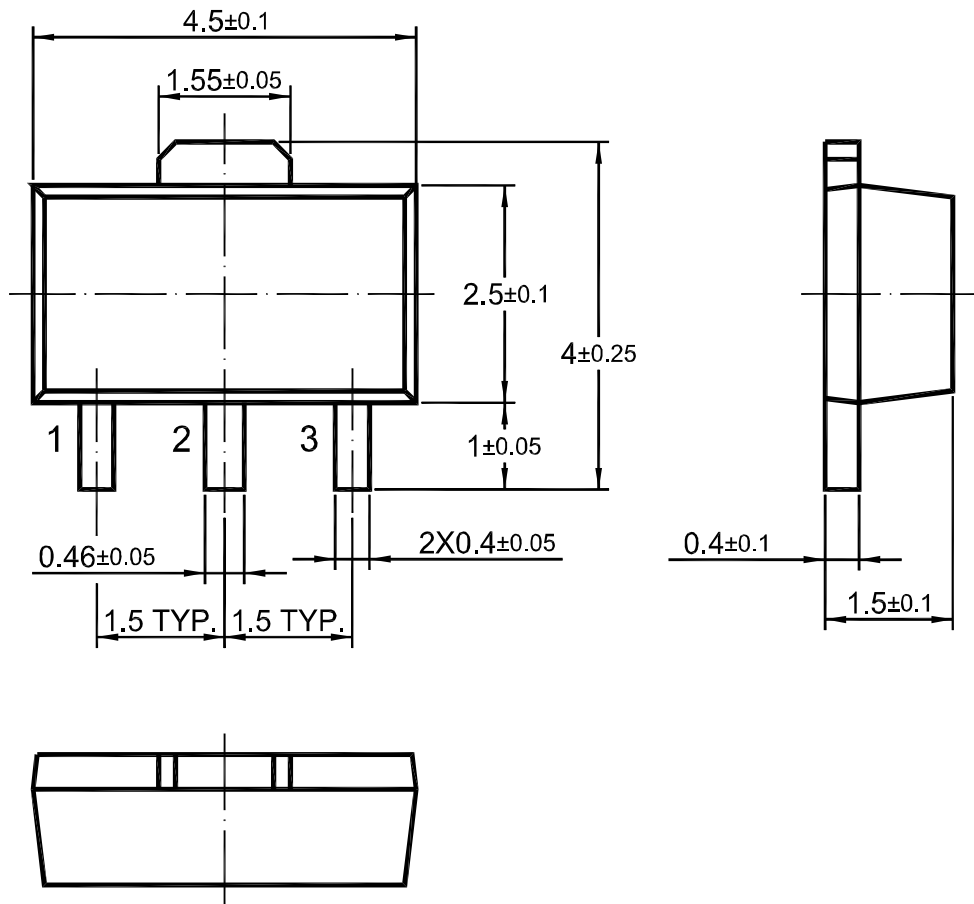

Dimensions in mm

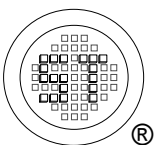

SEMTECH ELECTRONICS LTD.



Dated: 06/04/2016 Rev: 03