

# SOT-223 Plastic-Encapsulate Transistors

## PZT2907A TRANSISTOR (PNP)

### FEATURES

- Epitaxial planar die construction
- Complementary PNP Type available(PZT2222A)

### MARKING:

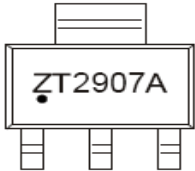

Solid dot = Green molding compound device,  
if none, the normal device.

### SOT-223

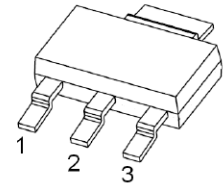

1. BASE
2. COLLECTOR
3. EMITTER

### MAXIMUM RATINGS (T<sub>a</sub>=25°C unless otherwise noted)

Symbol	Parameter	Value	Unit
V <sub>CBO</sub>	Collector-Base Voltage	-60	V
V <sub>CEO</sub>	Collector-Emitter Voltage	-60	V
V <sub>EBO</sub>	Emitter-Base Voltage	-5	V
I <sub>C</sub>	Collector Current -Continuous	-0.6	A
P <sub>C</sub>	Collector Power Dissipation	1	W
T <sub>J</sub>	Junction Temperature	150	°C
T <sub>stg</sub>	Storage Temperature	-55~+150	°C

### ELECTRICAL CHARACTERISTICS (T<sub>a</sub>=25°C unless otherwise specified)

Parameter	Symbol	Test conditions	Min	Typ	Max	Unit
Collector-base breakdown voltage	V <sub>(BR)CBO</sub>	I <sub>C</sub> =-10μA, I <sub>E</sub> =0	-60			V
Collector-emitter breakdown voltage	V <sub>(BR)CEO</sub>	I <sub>C</sub> =-10mA, I <sub>B</sub> =0	-60			V
Emitter-base breakdown voltage	V <sub>(BR)EBO</sub>	I <sub>E</sub> =-10μA, I <sub>C</sub> =0	-5			V
Collector cut-off current	I <sub>CBO</sub>	V <sub>CB</sub> =-50V, I <sub>E</sub> =0			-10	nA
Emitter cut-off current	I <sub>EBO</sub>	V <sub>EB</sub> =-5V, I <sub>C</sub> =0			-50	nA
DC current gain	h <sub>FE(1)</sub>	V <sub>CE</sub> =-10V, I <sub>C</sub> =-0.1mA	75			
	h <sub>FE(2)</sub>	V <sub>CE</sub> =-10V, I <sub>C</sub> =-1mA	100			
	h <sub>FE(3)</sub>	V <sub>CE</sub> =-10V, I <sub>C</sub> =-10mA	100			
	h <sub>FE(4)</sub>	V <sub>CE</sub> =-10V, I <sub>C</sub> =-150mA	100		300	
	h <sub>FE(5)</sub>	V <sub>CE</sub> =-10V, I <sub>C</sub> =-500mA	50			
Collector-emitter saturation voltage	V <sub>CE(sat)</sub>	I <sub>C</sub> =-150mA, I <sub>B</sub> =-15mA			-0.4	V
	V <sub>CE(sat)</sub>	I <sub>C</sub> =-500mA, I <sub>B</sub> =-50mA			-1.6	V
Base-emitter saturation voltage	V <sub>BE(sat)</sub>	I <sub>C</sub> =-150mA, I <sub>B</sub> =-15mA			-1.3	V
	V <sub>BE(sat)</sub>	I <sub>C</sub> =-500mA, I <sub>B</sub> =-50mA			-2.6	V
Transition frequency	f <sub>T</sub>	V <sub>CE</sub> =-20V, I <sub>C</sub> =-50mA, f=100MHz	200			MHz
Collector capacitance	C <sub>c</sub>	V <sub>CB</sub> =-10V, I <sub>E</sub> =0, f=1MHz			8	pF
Emitter capacitance	C <sub>e</sub>	V <sub>EB</sub> =-2V, I <sub>C</sub> =0, f=1MHz			30	pF
Delay time	t <sub>d</sub>	I <sub>C</sub> =-150mA I <sub>B1</sub> =- I <sub>B2</sub> =- 15mA			12	ns
Rise time	t <sub>r</sub>				30	ns
Storage time	t <sub>s</sub>				300	ns
Fall time	t <sub>f</sub>				65	ns

# Typical Characteristics

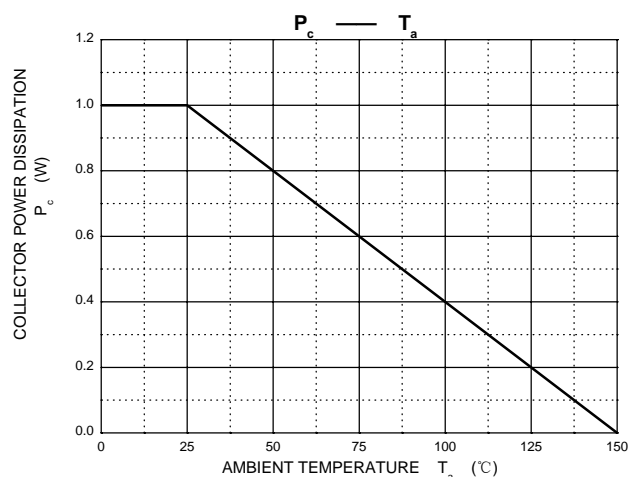
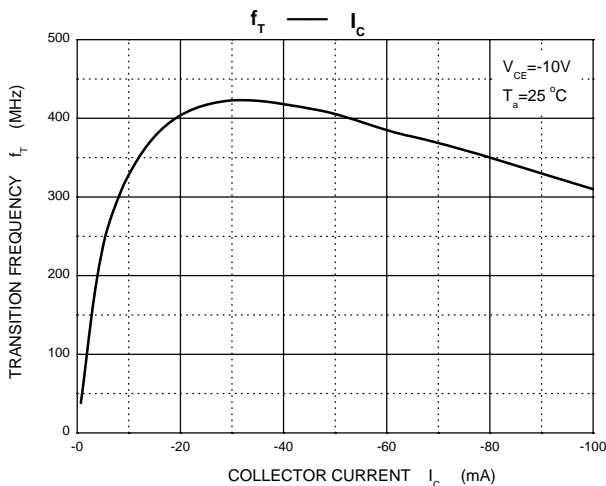
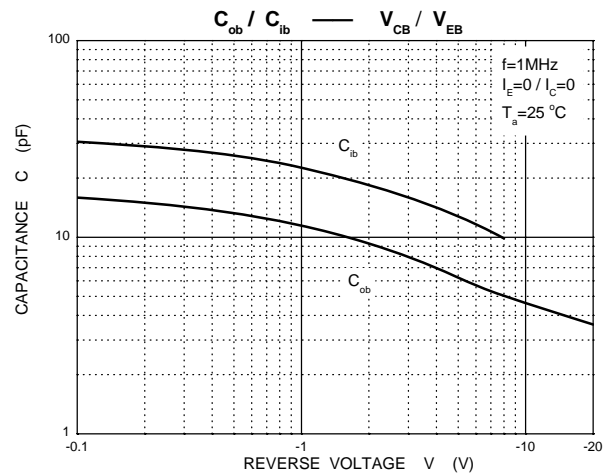
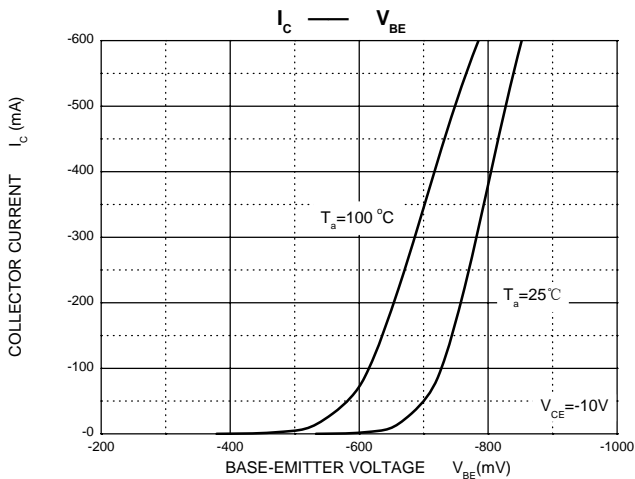
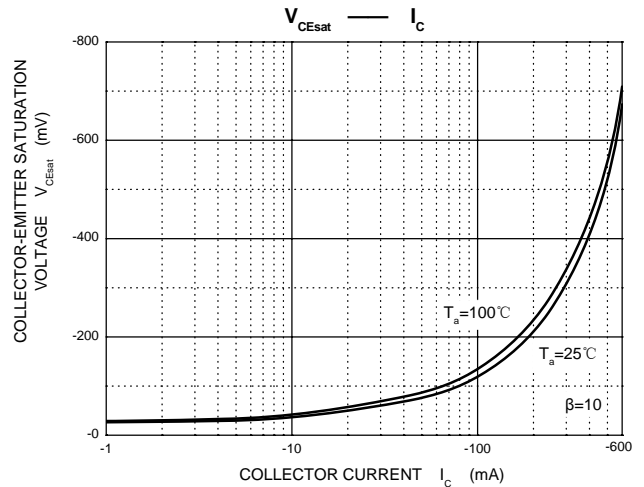
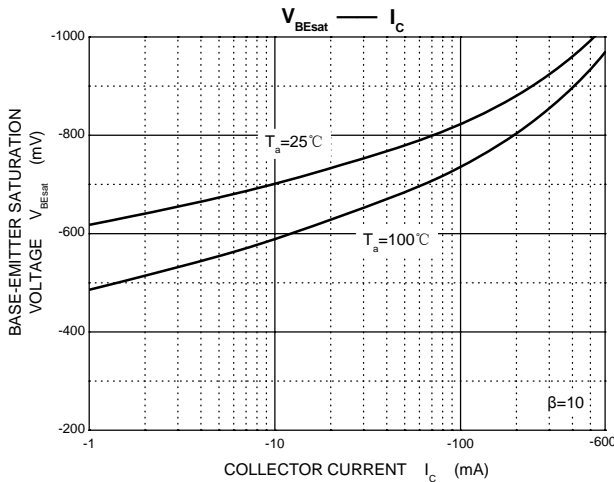
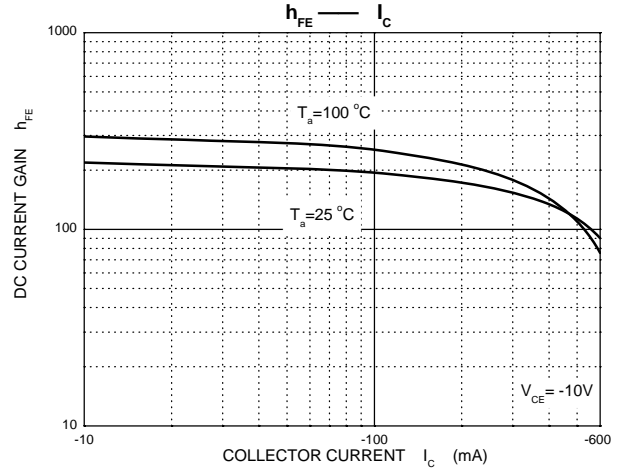
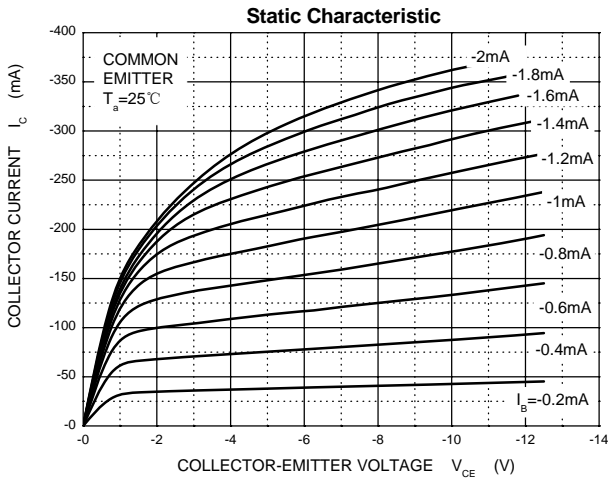

## SOT-223 Package Outline Dimensions

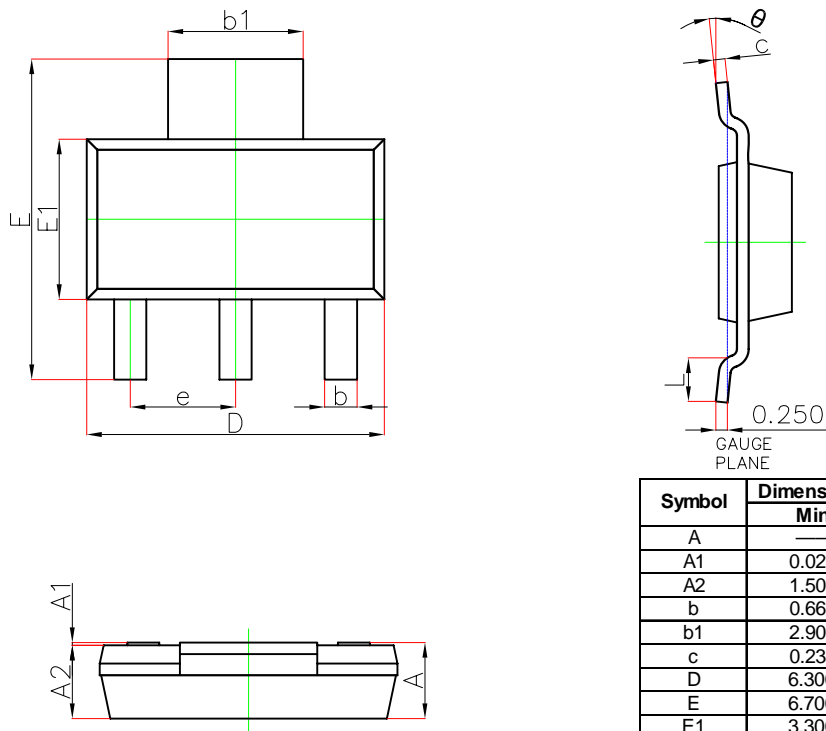

Symbol	Dimensions In Millimeters		Dimensions In Inches	
	Min.	Max.	Min.	Max.
A	—	1.800	—	0.071
A1	0.020	0.100	0.001	0.004
A2	1.500	1.700	0.059	0.067
b	0.660	0.840	0.026	0.033
$b_1$	2.900	3.100	0.114	0.122
c	0.230	0.350	0.009	0.014
D	6.300	6.700	0.248	0.264
E	6.700	7.300	0.264	0.287
$E_1$	3.300	3.700	0.130	0.146
e	2.300(BSC)		0.091(BSC)	
L	0.750	—	0.030	—
$\theta$	0°	10°	0°	10°

## SOT-223 Suggested Pad Layout

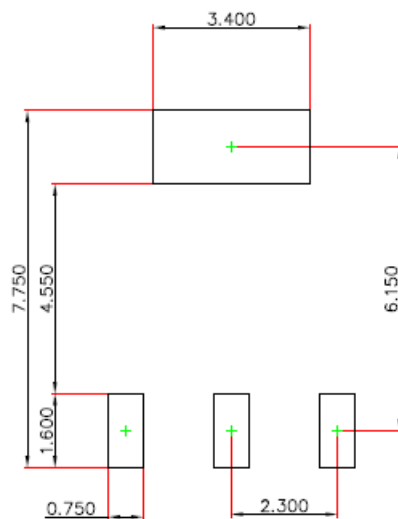

### Note:

1. Controlling dimension: in millimeters.
2. General tolerance:  $\pm 0.050$  mm.
3. The pad layout is for reference purposes only.

### NOTICE

JCET reserve the right to make modifications, enhancements, improvements, corrections or other changes without further notice to any product herein. JCET does not assume any liability arising out of the application or use of any product described herein.

# SOT-223 Tape and Reel

## SOT-223 Embossed Carrier Tape



**Packaging Description:**  
 SOT-223 parts are shipped in tape. The carrier tape is made from a dissipative (carbon filled) polycarbonate resin. The cover tape is a multilayer film (Heat Activated Adhesive in nature) primarily composed of polyester film, adhesive layer, sealant, and anti-static sprayed agent. These reeled parts in standard option are shipped with 2,500 units per 13" or 33.0cm diameter reel. The reels are clear in color and is made of polystyrene plastic (anti-static coated).

Dimensions are in millimeter										
Pkg type	A	B	C	d	E	F	P0	P	P1	W
SOT-223	6.765	7.335	1.88	Ø1.50	1.75	5.50	4.00	8.00	2.00	12.00

## SOT-223 Tape Leader and Trailer

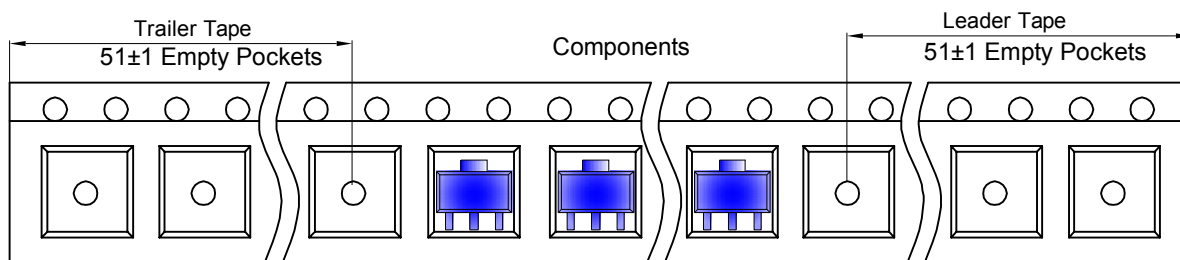

## SOT-223 Reel

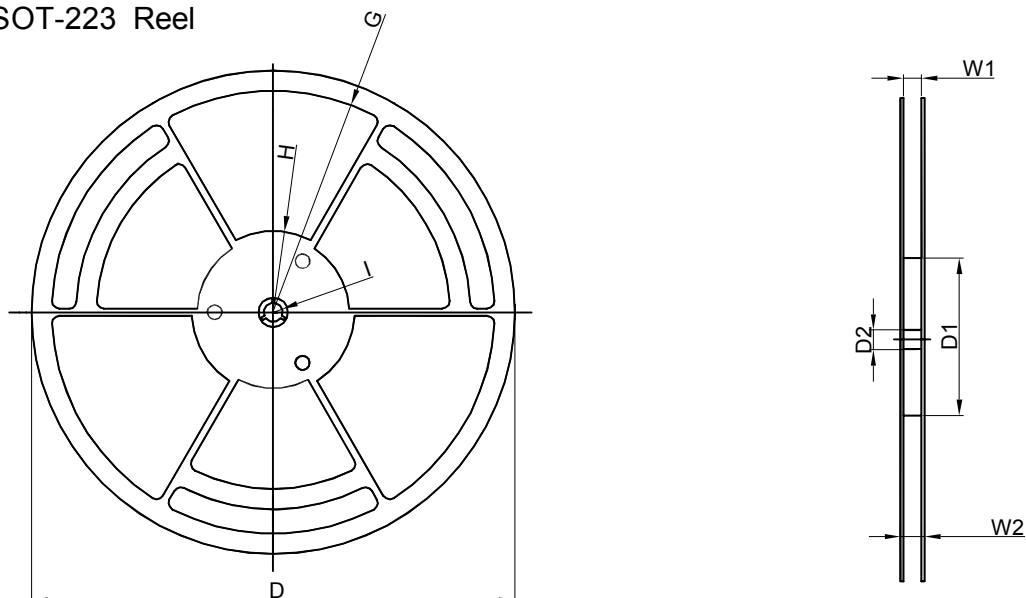

Dimensions are in millimeter								
Reel Option	D	D1	D2	G	H	I	W1	W2
13" Dia	Ø330.00	100.00	13.00	R151.00	R56.00	R6.50	12.40	17.60

REEL	Reel Size	Box	Box Size(mm)	Carton	Carton Size(mm)	G.W.(kg)
2,500 pcs	13 inch	2,500 pcs	336×336×48	20,000 pcs	445×355×365	