

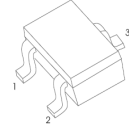

SOT-523 Plastic-Encapsulate Transistors

MMBT3906T TRANSISTOR (PNP)

SOT-523



1. BASE
2. EMITTER
3. COLLECTOR

FEATURES

- Epitaxial Planar Die Construction
- Complementary NPN Type Available
- Also Available in Lead Free Version

MARKING:3N

MAXIMUM RATINGS (T_a=25°C unless otherwise noted)

Symbol	Parameter	Value	Units
V _{CBO}	Collector-Base Voltage	-40	V
V _{CEO}	Collector-Emitter Voltage	-40	V
V _{EBO}	Emitter-Base Voltage	-5.0	V
I _C	Collector Current -Continuous	-200	mA
P _C	Collector Power Dissipation	150	mW
R _{θJA}	Thermal Resistance, Junction to Ambient	833	°C/W
T _J	Operating Temperature	150	°C
T _{stg}	Storage Temperature	-55-150	°C

ELECTRICAL CHARACTERISTICS(T_a=25°C unless otherwise specified)

Parameter	Symbol	Test conditions	Min	Typ	Max	Unit
Collector-base breakdown voltage	V _{(BR)CBO}	I _C =-10μA, I _E =0	-40			V
Collector-emitter breakdown voltage	V _{(BR)CEO}	I _C =-1mA, I _B =0	-40			V
Emitter-base breakdown voltage	V _{(BR)EBO}	I _E =-10μA, I _C =0	-5			V
Collector cut-off current	I _{CBO}	V _{CB} =-30V, I _E =0			-0.1	μA
Emitter cut-off current	I _{EBO}	V _{EB} =-5V, I _C =0			-0.1	μA
Collector cut-off current	I _{CEX}	V _{CB} =-30V, V _{BE(off)} =-3V			-0.05	μA
DC current gain	h _{FE(1)}	V _{CE} =-1V, I _C =-0.1mA	60			
	h _{FE(2)}	V _{CE} =-1V, I _C =-1mA	80			
	h _{FE(3)}	V _{CE} =-1V, I _C =-10mA	100		300	
	h _{FE(4)}	V _{CE} =-1V, I _C =-50mA	60			
	h _{FE(5)}	V _{CE} =-1V, I _C =-100mA	30			
Collector-emitter saturation voltage	V _{CE(sat)1}	I _C =-10mA, I _B =-1mA			-0.25	V
	V _{CE(sat)2}	I _C =-50mA, I _B =-5mA			-0.4	V
Base-emitter saturation voltage	V _{BE(sat)1}	I _C =-10mA, I _B =-1mA	-0.65		-0.85	V
	V _{BE(sat)2}	I _C =-50mA, I _B =-5mA			-0.95	V
Transition frequency	f _T	V _{CE} =-20V, I _C =-10mA, f=100MHz	250			MHz
Collector output capacitance	C _{obo}	V _{CB} =-5V, I _E =0, f=1MHz			4.5	pF
Input capacitance	C _{iob}	V _{EB} =-0.5V, I _E =0, f=1MHz			10	pF
Noise figure	NF	V _{CE} =-5V, I _C =0.1mA,			4	dB
Delay time	t _d	V _{CC} =-3V, V _{BE(OFF)} =-0.5V			35	nS
Rise time	t _r	I _C =-10mA, I _{B1} =-1mA			35	nS
Storage time	t _s	V _{CC} =-3V, I _C =-10mA			225	nS
Fall time	t _f	I _{B1} = I _{B2} =-1mA			75	nS

Typical Characteristics

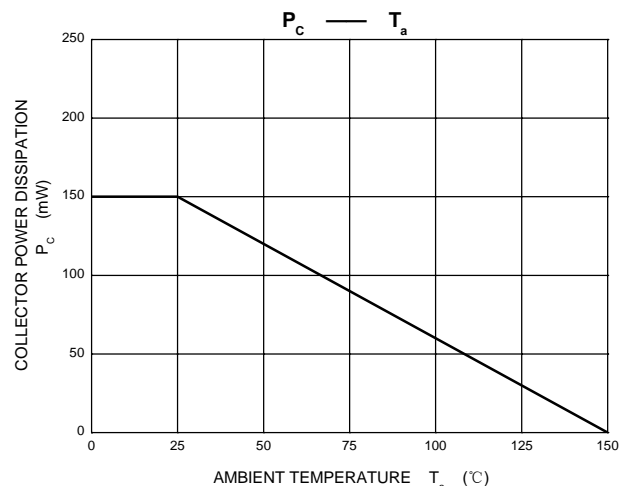
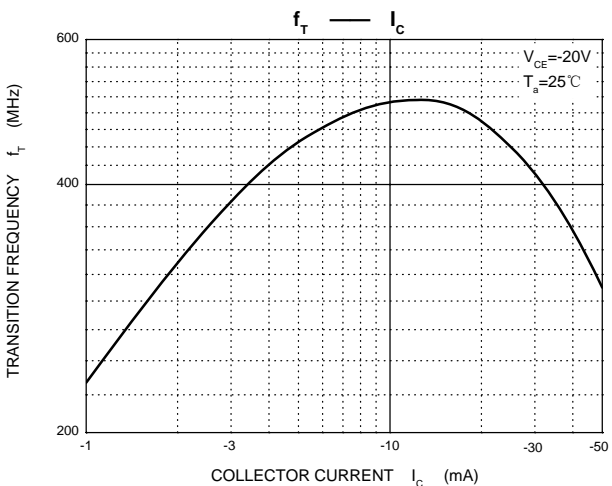
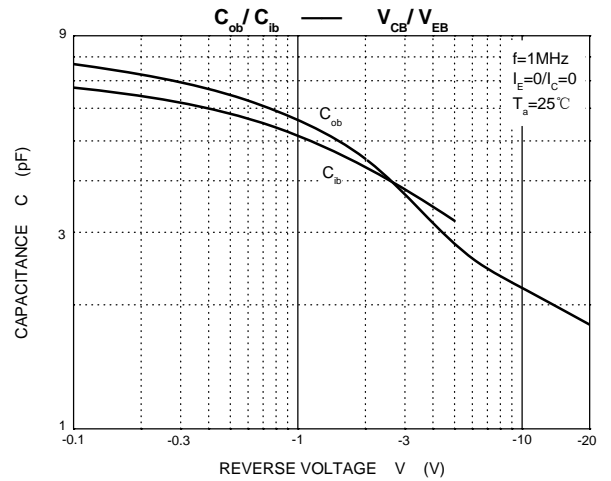
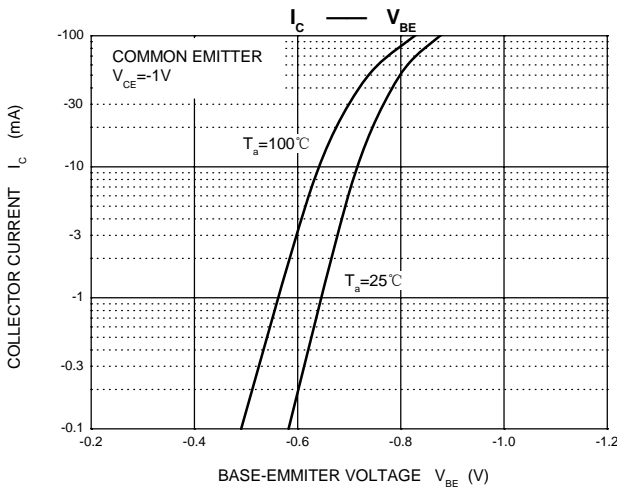
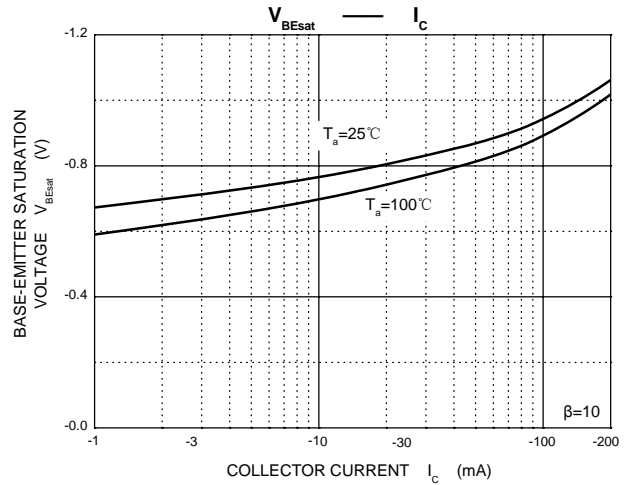
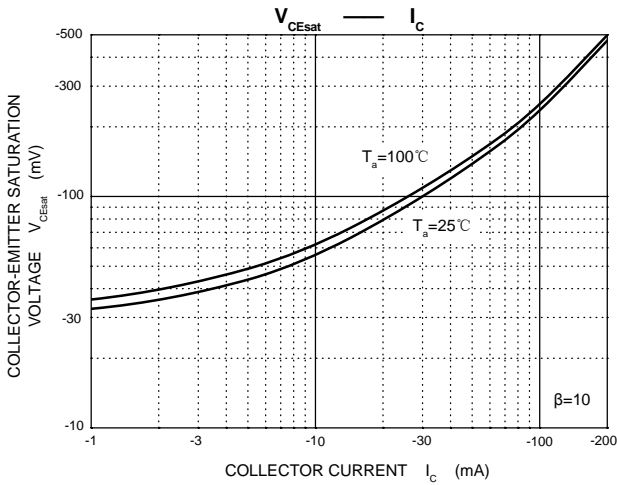
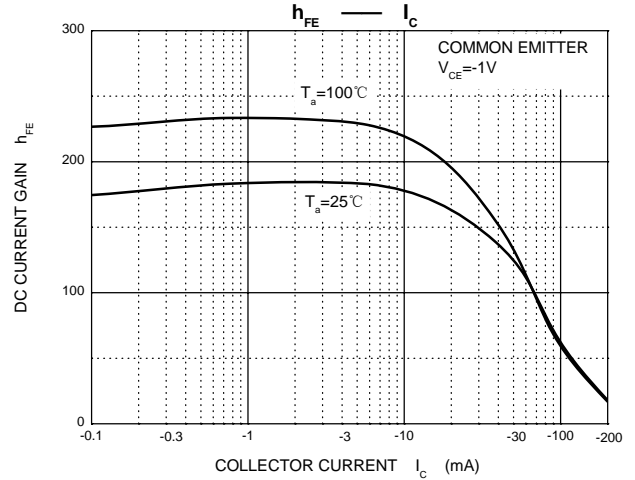
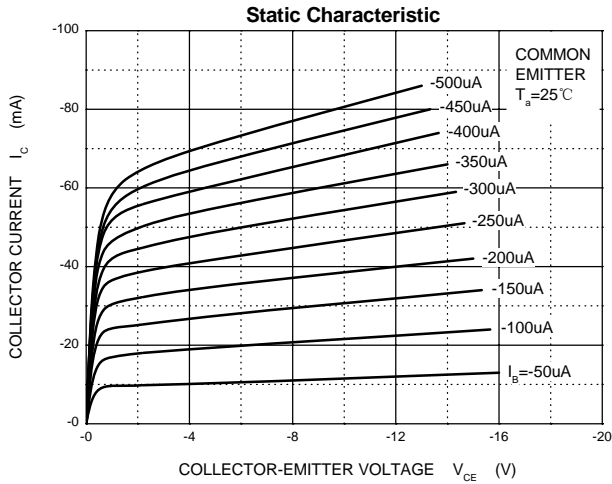

SOT-523 Package Outline Dimensions

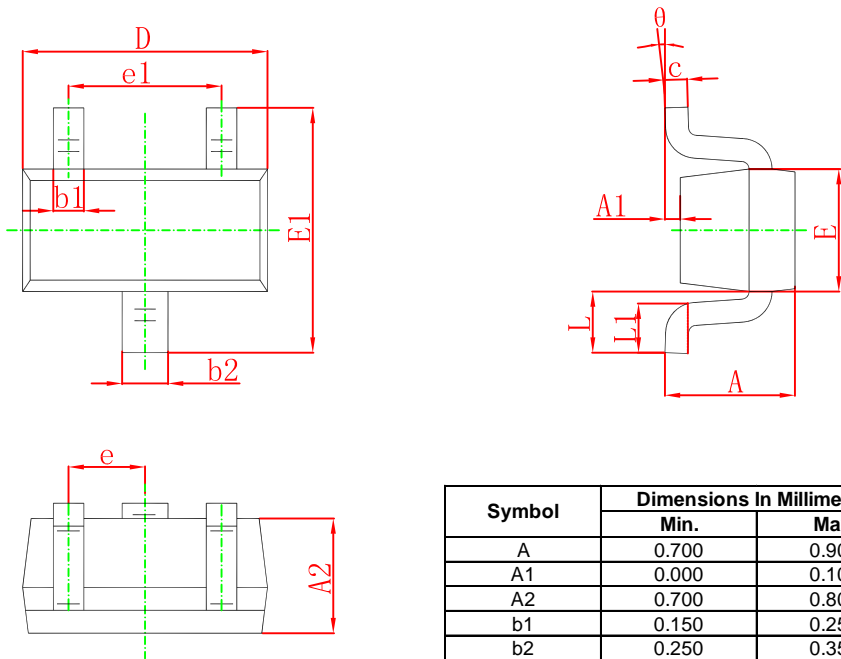

Symbol	Dimensions In Millimeters		Dimensions In Inches	
	Min.	Max.	Min.	Max.
A	0.700	0.900	0.028	0.035
A1	0.000	0.100	0.000	0.004
A2	0.700	0.800	0.028	0.031
b1	0.150	0.250	0.006	0.010
b2	0.250	0.350	0.010	0.014
c	0.100	0.200	0.004	0.008
D	1.500	1.700	0.059	0.067
E	0.700	0.900	0.028	0.035
E1	1.450	1.750	0.057	0.069
e	0.500 TYP.		0.020 TYP.	
e1	0.900	1.100	0.035	0.043
L	0.400 REF.		0.016 REF.	
L1	0.260	0.460	0.010	0.018
θ	0°	8°	0°	8°

SOT-523 Suggested Pad Layout

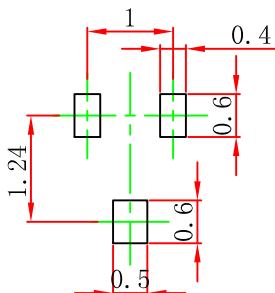

- Note:
1. Controlling dimension: in millimeters.
 2. General tolerance: $\pm 0.05\text{mm}$.
 3. The pad layout is for reference purposes only.

NOTICE

JCET reserve the right to make modifications, enhancements, improvements, corrections or other changes without further notice to any product herein. JCET does not assume any liability arising out of the application or use of any product described herein.

SOT-523 Tape and Reel

SOT-523 Embossed Carrier Tape

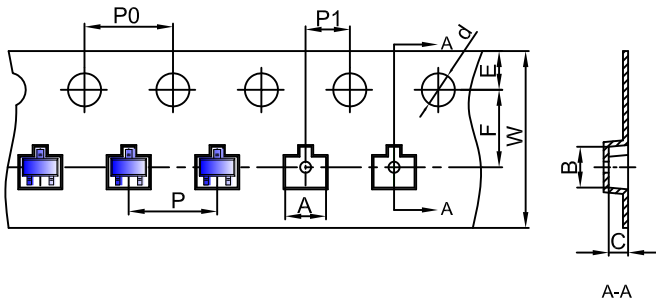

Packaging Description:

SOT-523 parts are shipped in tape. The carrier tape is made from a dissipative (carbon filled) polycarbonate resin. The cover tape is a multilayer film (Heat Activated Adhesive in nature) primarily composed of polyester film, adhesive layer, sealant, and anti-static sprayed agent. These reeled parts in standard option are shipped with 3,000 units per 7" or 17.8cm diameter reel. The reels are clear in color and is made of polystyrene plastic (anti-static coated).

Dimensions are in millimeter

Pkg type	A	B	C	d	E	F	P0	P	P1	W
SOT-523	1.85	1.85	0.875	Ø1.50	1.75	3.50	4.00	4.00	2.00	8.00

SOT-523 Tape Leader and Trailer

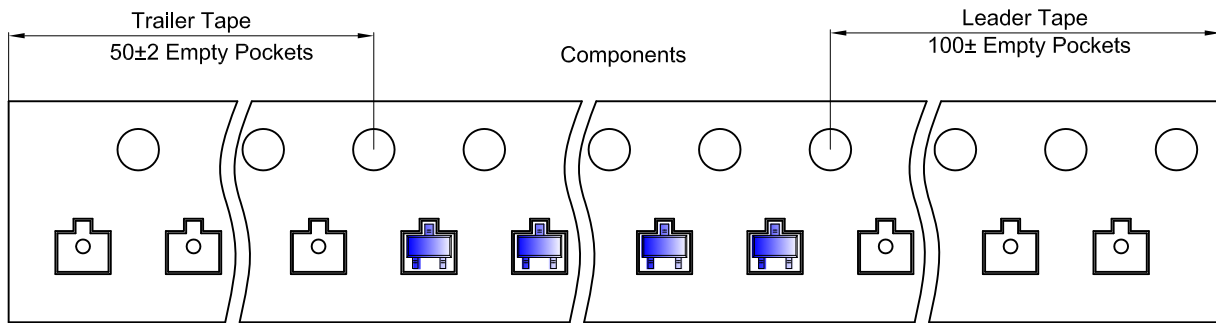

SOT-523 Reel

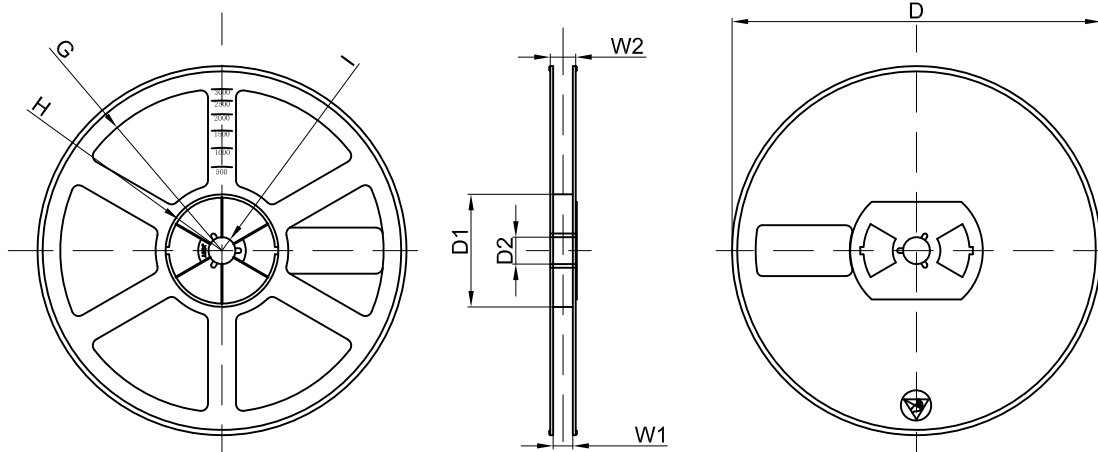

Dimensions are in millimeter

Reel Option	D	D1	D2	G	H	I	W1	W2
7"Dia	Ø178.00	54.40	13.00	R78.00	R25.60	R6.50	9.50	12.30

REEL	Reel Size	Box	Box Size(mm)	Carton	Carton Size(mm)	G.W.(kg)
3000 pcs	7 inch	45,000 pcs	203×203×195	180,000 pcs	438×438×220	