

TO-92 Plastic-Encapsulate Thyristors

MAC97A6,A8 TRIAC

MAIN FEATURES

Symbol	value	unit
$I_{T(RMS)}$	1	A
V_{DRM}/V_{RRM}	MAC97A6	400 V
	MAC97A8	600 V
I_{TSM}	8	A

TO-92

1. ANODE
2. GATE
3. ANODE

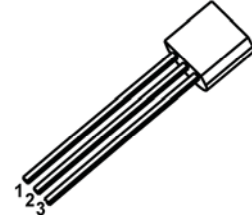

DESCRIPTION

Logic level sensitive gate triac intended to be interfaced directly to microcontrollers, logic integrated circuits and other low power gate trigger circuits.

FEATURES

- Blocking voltage to 400 V (MAC97A6)
- RMS on-state current to 0.6 A
- General purpose bidirectional switching

APPLICATIONS

- General purpose bidirectional switching
- Phase control applications
- Solid state relays

MARKING

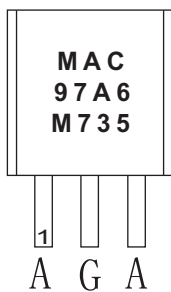

MARKING

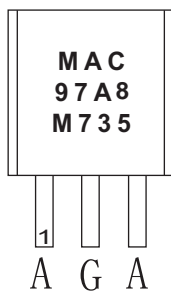

MAC97A6,MAC97A8=Device code
M735=Code

Equivalent Circuit



ORDERING INFORMATION

Part Number	Package	Packing Method	Pack Quantity
MAC97A6	TO-92	Bulk	1000pcs/Bag
MAC97A6-TA	TO-92	Tape	2000pcs/Box
MAC97A8	TO-92	Bulk	1000pcs/Bag
MAC97A8-TA	TO-92	Tape	2000pcs/Box

Limiting values

Symbol	Parameter	Conditions	Value	Unit
V_{DRM} / V_{RRM}	repetitive peak off-state voltage	MAC97A6 $T_j = 25 \text{ to } 125 \text{ } ^\circ\text{C}$	400	V
		MAC97A8 $T_j = 25 \text{ to } 125 \text{ } ^\circ\text{C}$	600	
I_{GM}	gate current(peak value)	$t = 2\mu\text{s max}$	1	A
V_{GM}	gate voltage(peak value)	$t = 2\mu\text{s max}$	5	V
P_{GM}	gate power(peak value)	$t = 2\mu\text{s max}$	5	W
T_j	Junction Temperature	-	-40 ~ 125	$^\circ\text{C}$
T_{stg}	Storage Temperature	-	-40 ~ 150	$^\circ\text{C}$

ELECTRICAL CHARACTERISTICS ($T_a=25^\circ\text{C}$ unless otherwise specified)

Parameter		Symbol	Test conditions	Min	Max	Unit	
Rated repetitive peak off-state/reverse voltage		V_{DRM}, V_{RRM}	$I_D=10\mu\text{A}$ MAC97A6 MAC97A8	400 600		V	
Rated repetitive peak off-state current		I_{DRM}	$V_D=V_{DRM}$		10	μA	
On-state voltage		V_{TM}	$I_T=1\text{A}, I_G=50\text{mA}$		1.9	V	
Gate trigger current	I	I_{GT}	$T_2(+), G(+)$	$V_D=12\text{V}$ $R_L=100\Omega$		5	mA
	II		$T_2(+), G(-)$			5	mA
	III		$T_2(-), G(-)$			5	mA
	IV		$T_2(-), G(+)$			-	mA
Gate trigger voltage	I	V_{GT}	$T_2(+), G(+)$	$V_D=12\text{V}$ $R_L=100\Omega$		1.5	V
	II		$T_2(+), G(-)$			1.5	V
	III		$T_2(-), G(-)$			1.5	V
	IV		$T_2(-), G(+)$			-	V
Holding current		I_H	$I_T=600\text{mA}, I_G=20\text{mA}$		10	mA	

TO-92 Package Outline Dimensions

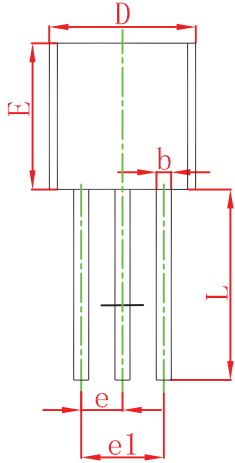
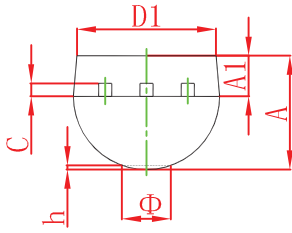

Symbol	Dimensions In Millimeters		Dimensions In Inches	
	Min	Max	Min	Max
A	3.300	3.700	0.130	0.146
A1	1.100	1.400	0.043	0.055
b	0.380	0.550	0.015	0.022
c	0.360	0.510	0.014	0.020
D	4.300	4.700	0.169	0.185
D1	3.430		0.135	
E	4.300	4.700	0.169	0.185
e	1.270 TYP		0.050 TYP	
e1	2.440	2.640	0.096	0.104
L	14.100	14.500	0.555	0.571
Φ		1.600		0.063
h	0.000	0.380	0.000	0.015

TO-92 Suggested Pad Layout

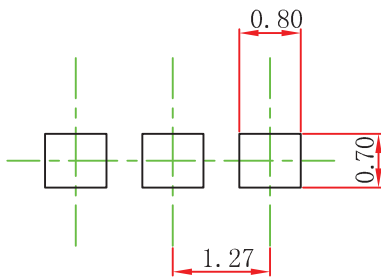

Note:

1. Controlling dimension: in millimeters.
2. General tolerance: $\pm 0.05\text{mm}$.
3. The pad layout is for reference purposes only.

NOTICE

JCET reserve the right to make modifications, enhancements, improvements, corrections or other changes without further notice to any product herein. JCET does not assume any liability arising out of the application or use of any product described herein.

TO-92 PACKAGE TAPEING DIMENSION

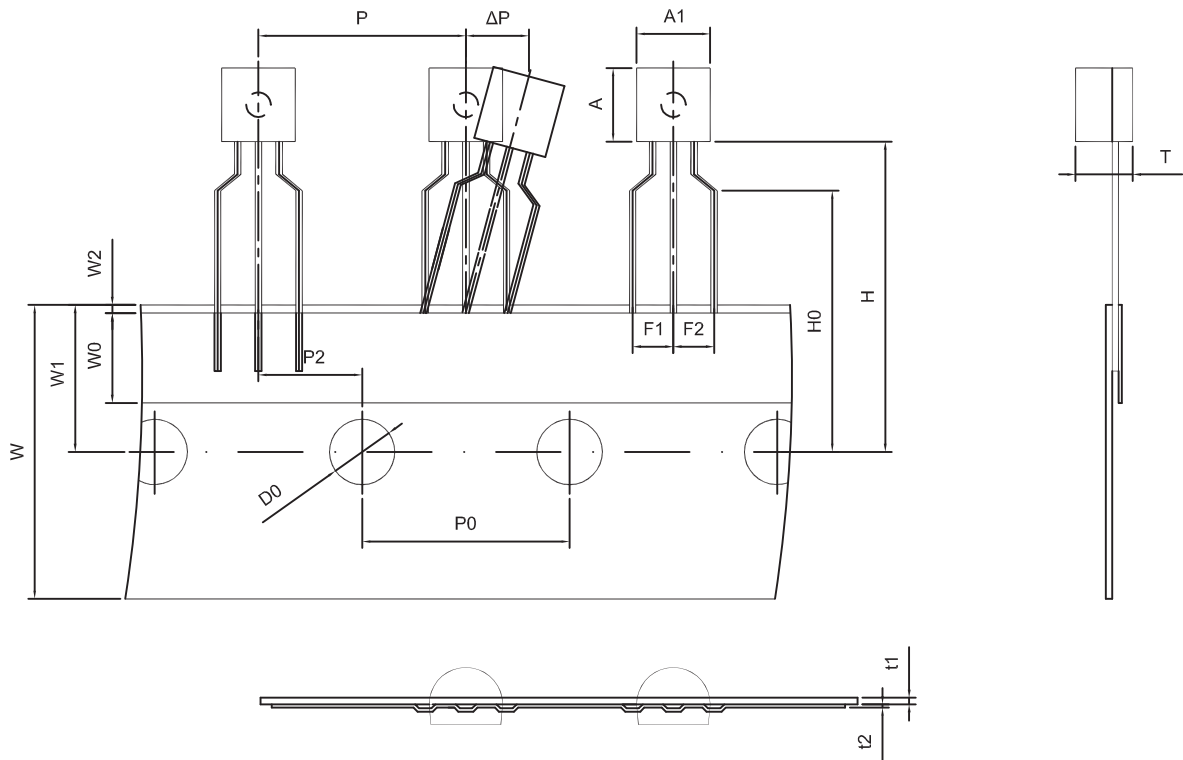

Dimiensions are in millimeter								
A1	A	T	P	P0	P2	F1	F2	W
4.5	4.5	3.5	12.7	12.7	6.35	2.5	2.5	18.0
W0	W1	W2	H	H0	D0	t1	t2	ΔP
6.0	9.0	1.0 MAX.	19.0	16.0	4.0	0.4	0.2	0

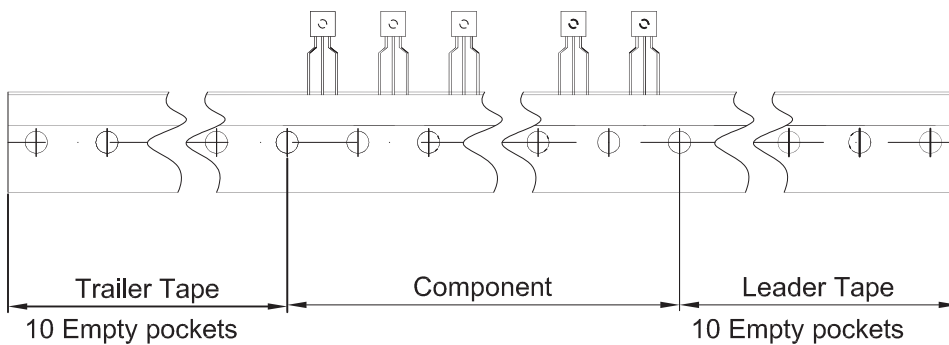

Package	Box	Box Size(mm)	Carton	Carton Size(mm)
TO-92	2000 pcs	333×162×43	20,000 pcs	350×340×250