

SOT-89-3L Plastic-Encapsulate Transistors

KTA1666

TRANSISTOR (PNP)

FEATURES

- Complementary to KTC4379
- Small Flat Package
- Low Saturation Voltage
- Power Amplifier and Switching Application

SOT-89-3L

1. BASE
2. COLLECTOR
3. EMITTER

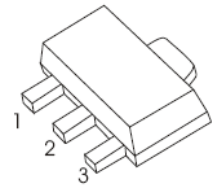

MAXIMUM RATINGS ($T_a=25^{\circ}\text{C}$ unless otherwise noted)

Symbol	Parameter	Value	Unit
V_{CBO}	Collector-Base Voltage	-50	V
V_{CEO}	Collector-Emitter Voltage	-50	V
V_{EBO}	Emitter-Base Voltage	-5	V
I_C	Collector Current	-2	A
P_C	Collector Power Dissipation	500	mW
$R_{\theta JA}$	Thermal Resistance From Junction To Ambient	250	$^{\circ}\text{C}/\text{W}$
T_j	Junction Temperature	150	$^{\circ}\text{C}$
T_{stg}	Storage Temperature	-55~+150	$^{\circ}\text{C}$

ELECTRICAL CHARACTERISTICS ($T_a=25^{\circ}\text{C}$ unless otherwise specified)

Parameter	Symbol	Test conditions	Min	Typ	Max	Unit
Collector-base breakdown voltage	$V_{(BR)CBO}$	$I_C = -1\text{mA}, I_E = 0$	-50			V
Collector-emitter breakdown voltage	$V_{(BR)CEO}$	$I_C = -10\text{mA}, I_B = 0$	-50			V
Emitter-base breakdown voltage	$V_{(BR)EBO}$	$I_E = -1\text{mA}, I_C = 0$	-5			V
Collector cut-off current	I_{CBO}	$V_{CB} = -50\text{V}, I_E = 0$			-100	nA
Emitter cut-off current	I_{EBO}	$V_{EB} = -5\text{V}, I_C = 0$			-100	nA
DC current gain	$h_{FE(1)}^*$	$V_{CE} = -2\text{V}, I_C = -500\text{mA}$	70		240	
	$h_{FE(2)}^*$	$V_{CE} = -2\text{V}, I_C = -1.5\text{A}$	40			
Collector-emitter saturation voltage	$V_{CE(sat)}^*$	$I_C = -1\text{A}, I_B = -50\text{mA}$			-0.5	V
Base-emitter saturation voltage	$V_{BE(sat)}^*$	$I_C = -1\text{A}, I_B = -50\text{mA}$			-1.2	V
Collector output capacitance	C_{ob}	$V_{CB} = -10\text{V}, I_E = 0, f = 1\text{MHz}$			40	pF
Transition frequency	f_T	$V_{CE} = -2\text{V}, I_C = -500\text{mA}$		120		MHz

*Pulse test: pulse width $\leq 300\text{mS}$, duty cycle $\leq 2.0\%$.

CLASSIFICATION OF $h_{FE(1)}$

RANK	O	Y
RANGE	70 - 140	120 - 240
MARKING	WO	WY

Typical Characteristics

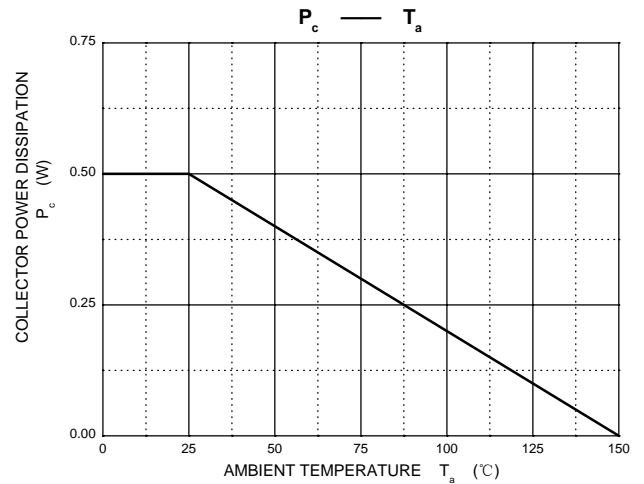
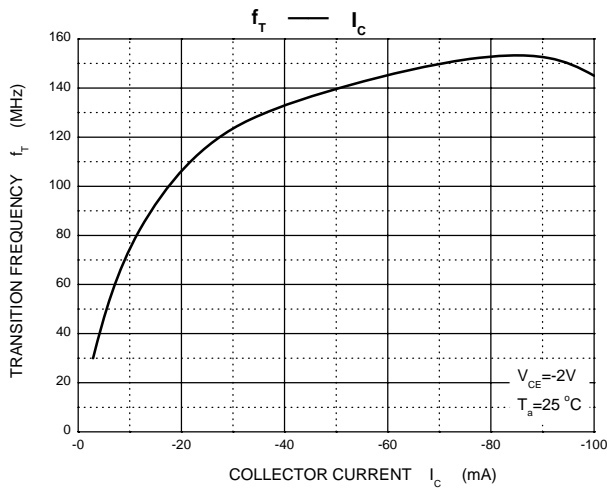
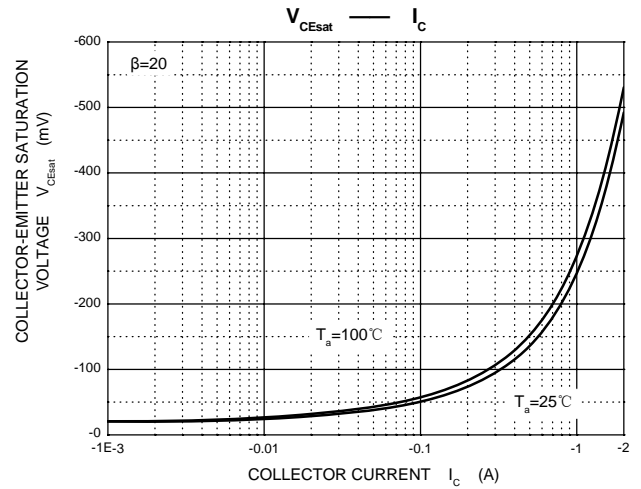
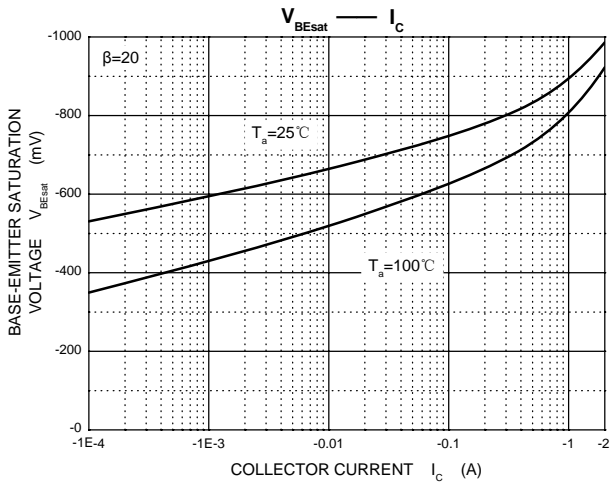
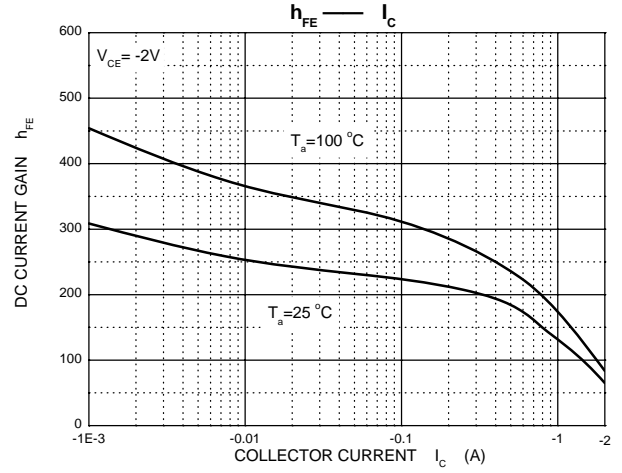
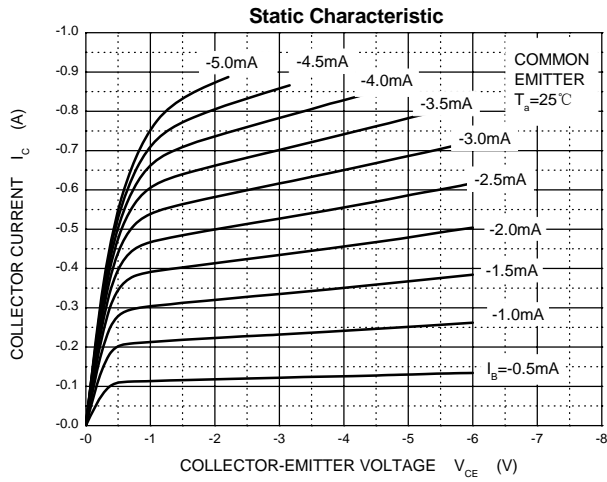

SOT-89-3L Package Outline Dimensions

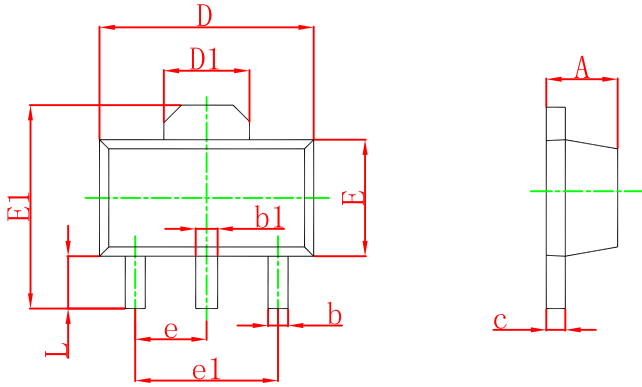

Symbol	Dimensions In Millimeters		Dimensions In Inches	
	Min	Max	Min	Max
A	1.400	1.600	0.055	0.063
b	0.320	0.520	0.013	0.020
b1	0.400	0.580	0.016	0.023
c	0.350	0.440	0.014	0.017
D	4.400	4.600	0.173	0.181
D1	1.550 REF.		0.061 REF.	
E	2.300	2.600	0.091	0.102
E1	3.940	4.250	0.155	0.167
e	1.500 TYP.		0.060 TYP.	
e1	3.000 TYP.		0.118 TYP.	
L	0.900	1.200	0.035	0.047

SOT-89-3L Suggested Pad Layout

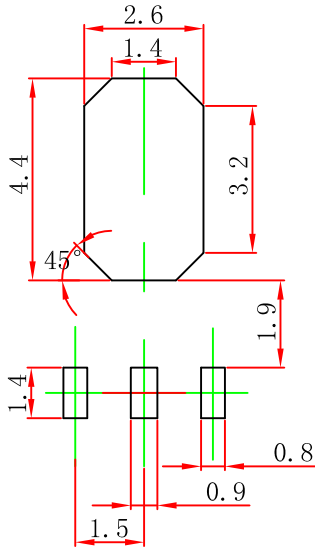

Note:

1. Controlling dimension: in millimeters.
2. General tolerance: ± 0.05 mm.
3. The pad layout is for reference purposes only.

NOTICE

JCET reserve the right to make modifications, enhancements, improvements, corrections or other changes without further notice to any product herein. JCET does not assume any liability arising out of the application or use of any product described herein.

SOT-89-3L Tape and Reel

SOT-89-3L Embossed Carrier Tape

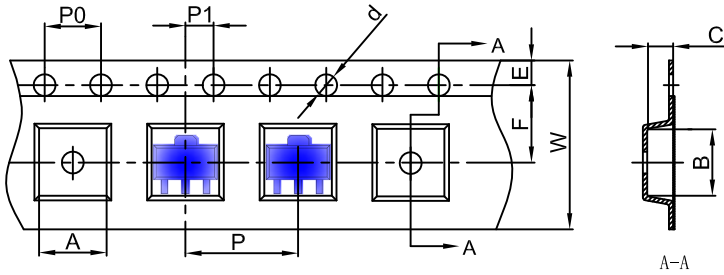

Packaging Description:
 SOT-89-3L parts are shipped in tape. The carrier tape is made from a dissipative (carbon filled) polycarbonate resin. The cover tape is a multilayer film (Heat Activated Adhesive in nature) primarily composed of polyester film, adhesive layer, sealant, and anti-static sprayed agent. These reeled parts in standard option are shipped with 1,000 units per 7" or 18.0 cm diameter reel. The reels are clear in color and is made of polystyrene plastic (anti-static coated).

Dimensions are in millimeter										
Pkg type	A	B	C	d	E	F	P0	P	P1	W
SOT-89-3L	4.85	4.45	1.85	Ø1.50	1.75	5.50	4.00	8.00	2.00	12.00

SOT-89-3L Tape Leader and Trailer

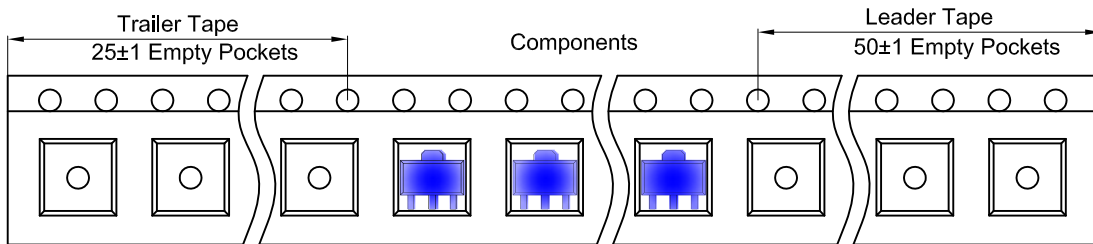

SOT-89-3L Reel

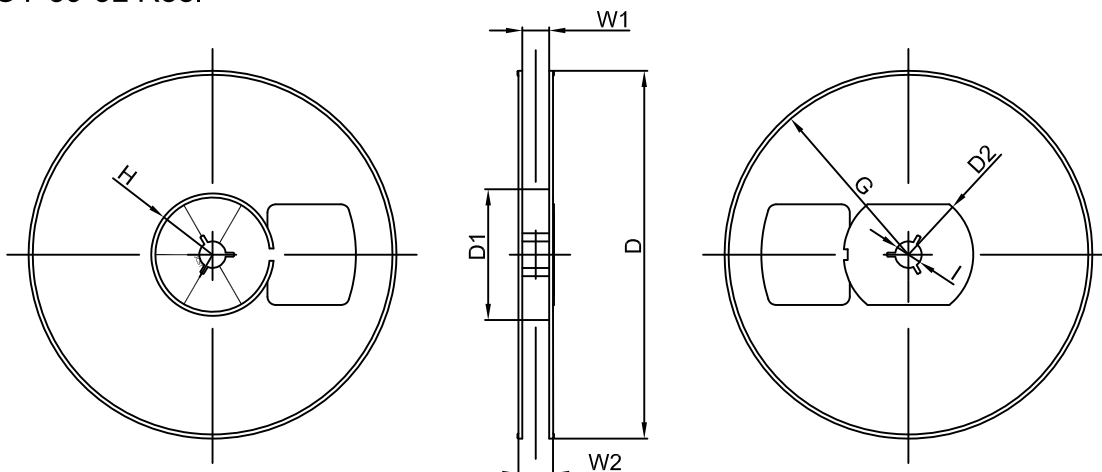

Dimensions are in millimeter								
Reel Option	D	D1	D2	G	H	I	W1	W2
7" Dia	Ø180.00	60.00	R32.00	R86.50	R30.00	Ø13.00	13.20	16.50

REEL	Reel Size	Box	Box Size(mm)	Carton	Carton Size(mm)	G.W.(kg)
1000 pcs	7 inch	10,000 pcs	203×203×195	40,000 pcs	438×438×220	