

# FCX491A

## NPN Silicon Planar Medium Power Transistor

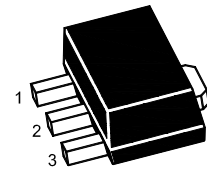

1.Base 2.Collector 3.Emitter  
SOT-89 Plastic Package

### Absolute Maximum Ratings ( $T_a = 25^\circ\text{C}$ )

Parameter	Symbol	Value	Unit
Collector Base Voltage	$V_{CBO}$	40	V
Collector Emitter Voltage	$V_{CEO}$	40	V
Emitter Base Voltage	$V_{EBO}$	5	V
Collector Current	$I_C$	1	A
Peak Collector Current	$I_{CM}$	2	A
Collector Power Dissipation	$P_{tot}$	1	W
Operating and Storage Temperature Range	$T_j, T_{stg}$	- 65 to + 150	$^\circ\text{C}$

### Characteristics at $T_a = 25^\circ\text{C}$

Parameter	Symbol	Min.	Max.	Unit
DC Current Gain at $V_{CE} = 5\text{ V}, I_C = 1\text{ mA}$	$h_{FE}$	300	-	-
at $V_{CE} = 5\text{ V}, I_C = 500\text{ mA}$	$h_{FE}$	300	900	-
at $V_{CE} = 5\text{ V}, I_C = 1\text{ A}$	$h_{FE}$	200	-	-
at $V_{CE} = 5\text{ V}, I_C = 2\text{ A}$	$h_{FE}$	35	-	-
Collector Base Cutoff Current at $V_{CB} = 30\text{ V}$	$I_{CBO}$	-	100	nA
Collector Emitter Cutoff Current at $V_{CE} = 30\text{ V}$	$I_{CES}$	-	100	nA
Emitter Base Cutoff Current at $V_{EB} = 4\text{ V}$	$I_{EBO}$	-	100	nA
Collector Base Breakdown Voltage at $I_C = 100\text{ }\mu\text{A}$	$V_{(BR)CBO}$	40	-	V
Collector Emitter Breakdown Voltage at $I_C = 10\text{ mA}$	$V_{(BR)CEO}$	40	-	V
Emitter Base Breakdown Voltage at $I_E = 100\text{ }\mu\text{A}$	$V_{(BR)EBO}$	5	-	V
Collector Emitter Saturation Voltage at $I_C = 500\text{ mA}, I_B = 50\text{ mA}$	$V_{CE(sat)}$	-	0.3	V
at $I_C = 1\text{ A}, I_B = 100\text{ mA}$		-	0.5	
Base Emitter Saturation Voltage at $I_C = 1\text{ A}, I_B = 100\text{ mA}$	$V_{BE(sat)}$	-	1.1	V
Base Emitter on Voltage at $V_{CE} = 5\text{ V}, I_C = 1\text{ A}$	$V_{BE(on)}$	-	1	V
Transition Frequency at $V_{CE} = 10\text{ V}, I_C = 50\text{ mA}, f = 100\text{ MHz}$	$f_T$	150	-	MHz
Collector Base Capacitance at $V_{CB} = 10\text{ V}, f = 1\text{ MHz}$	$C_{ob}$	-	10	pF

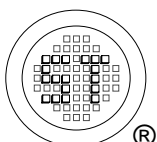

**SEMTECH ELECTRONICS LTD.**  
Subsidiary of Sino-Tech International (BVI) Limited



# FCX491A

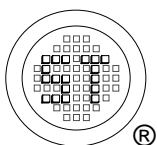
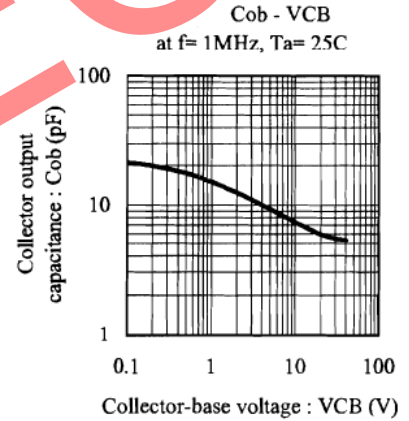
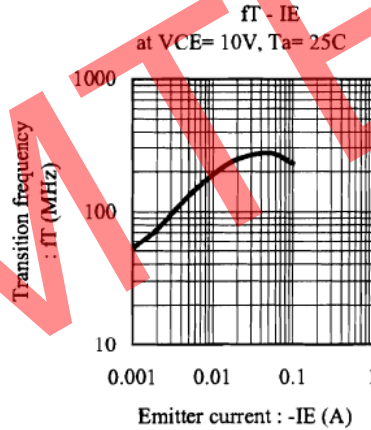
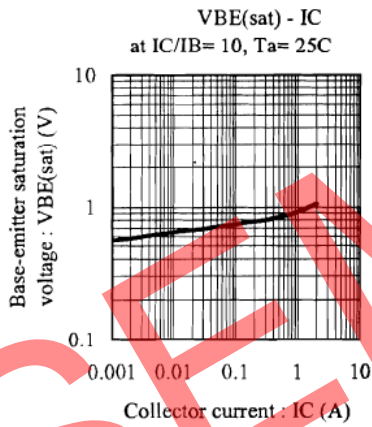
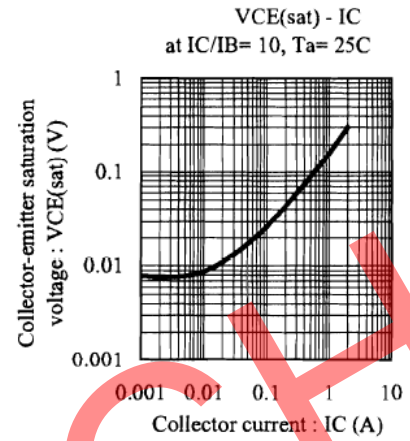
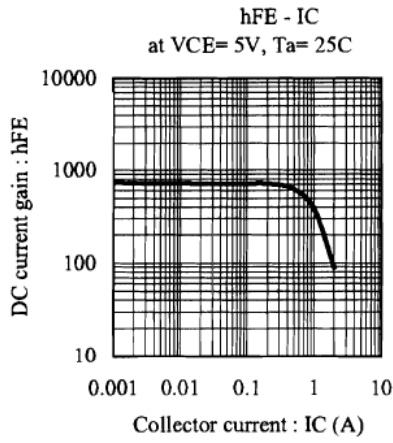
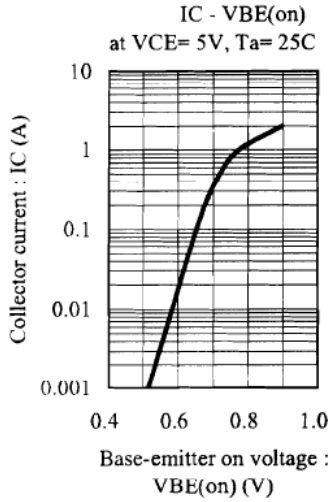

**SEMTECH ELECTRONICS LTD.**  
Subsidiary of Sino-Tech International (BVI) Limited



# FCX491A

## SOT-89 PACKAGE OUTLINE

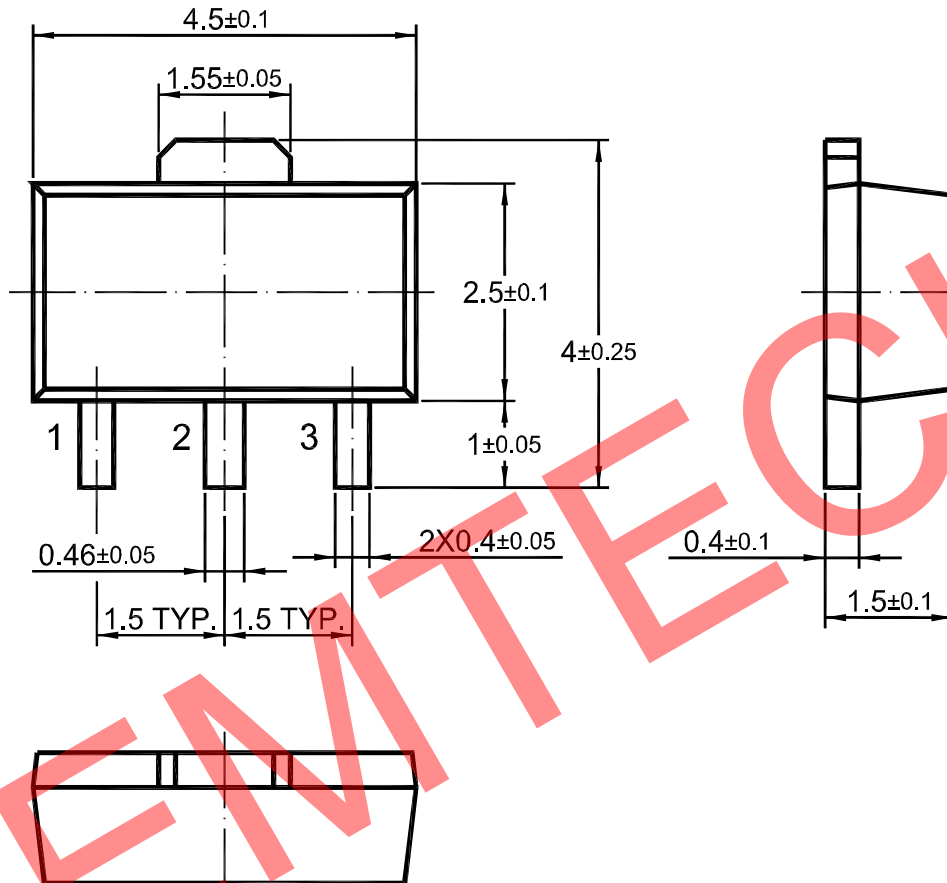

Dimensions in mm

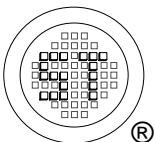

**SEMTECH ELECTRONICS LTD.**  
Subsidiary of Sino-Tech International (BVI) Limited



Dated: 27/09/2013 Rev: 02