



## TO-220-3L Plastic-Encapsulate Regulators

### CJ78M05 Three-terminal positive voltage regulator

#### FEATURES

- Maximum output current  
 $I_{OM}: 0.5\text{ A}$
- Output voltage  
 $V_O: 5\text{ V}$
- Continuous total dissipation  
 $P_D: 1.5\text{ W}$  ( $T_a = 25\text{ }^\circ\text{C}$ )

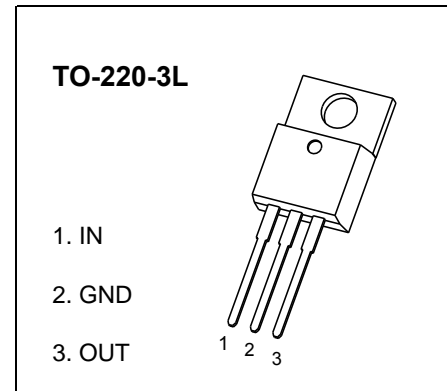

#### ABSOLUTE MAXIMUM RATINGS (Operating temperature range applies unless otherwise specified)

Parameter	Symbol	Value	Unit
Input Voltage	$V_i$	35	V
Thermal Resistance from Junction to Ambient	$R_{\theta JA}$	66.7	$^\circ\text{C/W}$
Operating Junction Temperature Range	$T_{OPR}$	-25~+125	$^\circ\text{C}$
Storage Temperature Range	$T_{STG}$	-65~+150	$^\circ\text{C}$

#### ELECTRICAL CHARACTERISTICS AT SPECIFIED VIRTUAL JUNCTION TEMPERATURE ( $V_i=10\text{V}, I_o=350\text{mA}, C_i=0.33\mu\text{F}, C_o=0.1\mu\text{F}$ , unless otherwise specified)

Parameter	Symbol	Test conditions	Min	Typ	Max	Unit
Output Voltage	$V_o$	$25\text{ }^\circ\text{C}$	4.8	5	5.2	V
		$7\text{V} \leq V_i \leq 20\text{V}, I_o=5\text{mA}-350\text{mA}$	-25~125 $^\circ\text{C}$	4.75	5	5.25
Load Regulation	$\Delta V_o$	$I_o=5\text{mA}-0.5\text{A}$	$25\text{ }^\circ\text{C}$	15	100	mV
		$I_o=5\text{mA}-200\text{mA}$	$25\text{ }^\circ\text{C}$	5	50	mV
Line Regulation	$\Delta V_o$	$7\text{V} \leq V_i \leq 25\text{V}, I_o=200\text{mA}$	$25\text{ }^\circ\text{C}$	3	100	mV
		$8\text{V} \leq V_i \leq 25\text{V}, I_o=200\text{mA}$	$25\text{ }^\circ\text{C}$	1	50	mV
Quiescent Current	$I_q$	$25\text{ }^\circ\text{C}$		4.2	6	mA
Quiescent Current Change	$\Delta I_q$	$8\text{V} \leq V_i \leq 25\text{V}, I_o=200\text{mA}$	-25~125 $^\circ\text{C}$		0.8	mA
		$5\text{mA} \leq I_o \leq 350\text{mA}$	-25~125 $^\circ\text{C}$		0.5	mA
Output Noise Voltage	$V_N$	$10\text{Hz} \leq f \leq 100\text{KHz}$	$25\text{ }^\circ\text{C}$	40	200	$\mu\text{V}/V_o$
Ripple Rejection	RR	$8\text{V} \leq V_i \leq 18\text{V}, f=120\text{Hz}, I_o=300\text{mA}$	-25~125 $^\circ\text{C}$	62	80	dB
Dropout Voltage	$V_d$	$I_o=350\text{mA}$	$25\text{ }^\circ\text{C}$	2	2.5	V
Short Circuit Current	$I_{sc}$	$V_i=10\text{V}$	$25\text{ }^\circ\text{C}$	300		mA
Peak Current	$I_{pk}$	$25\text{ }^\circ\text{C}$		0.5		A

\* Pulse test.

#### TYPICAL APPLICATION

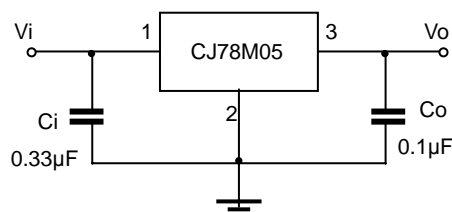

Note: Bypass capacitors are recommended for optimum stability and transient response and should be located as close as possible to the regulators.

# Typical Characteristics

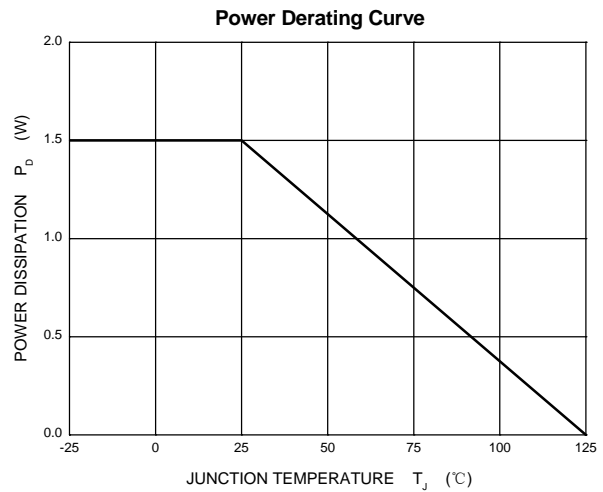
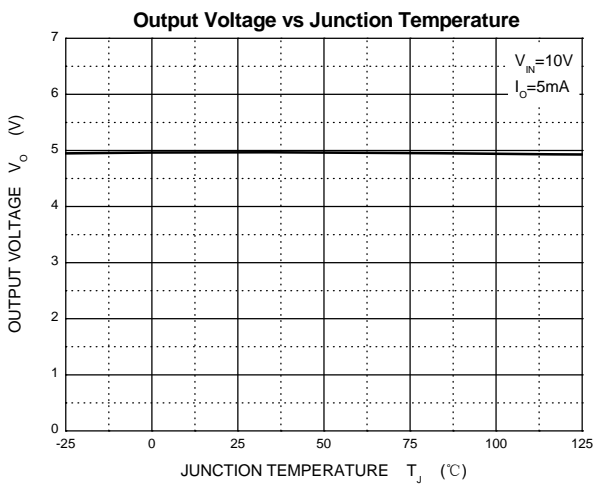
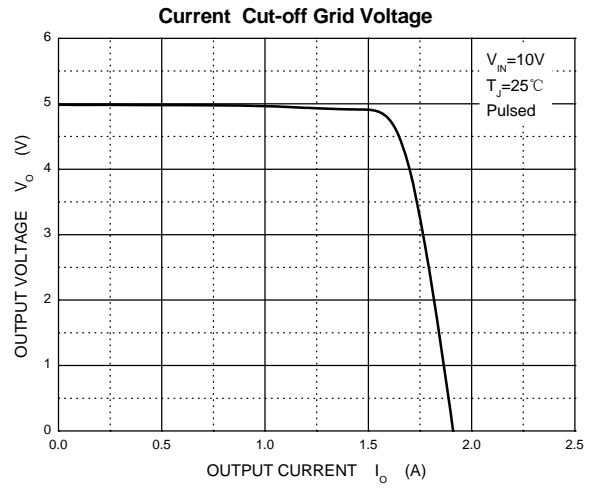
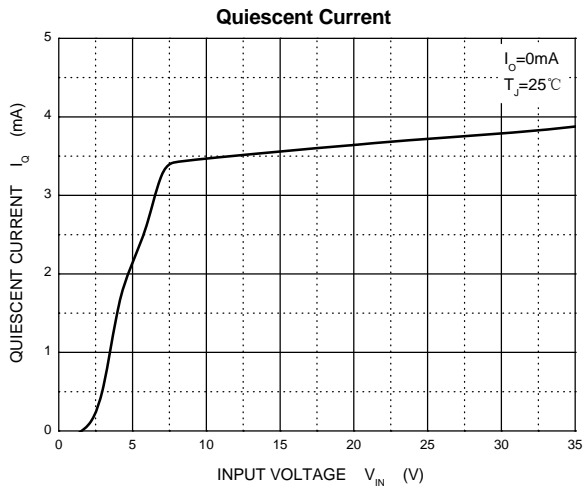
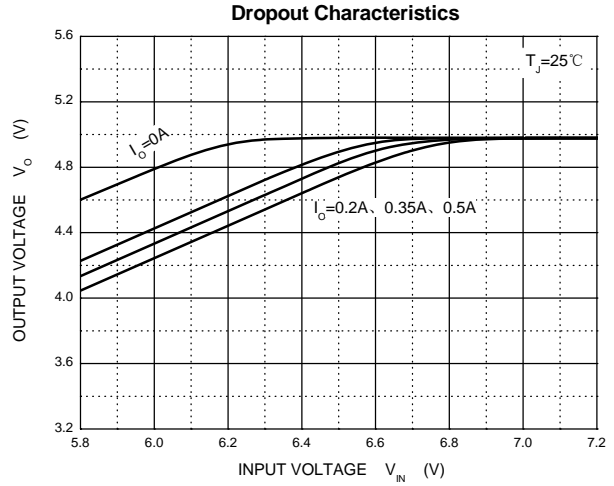
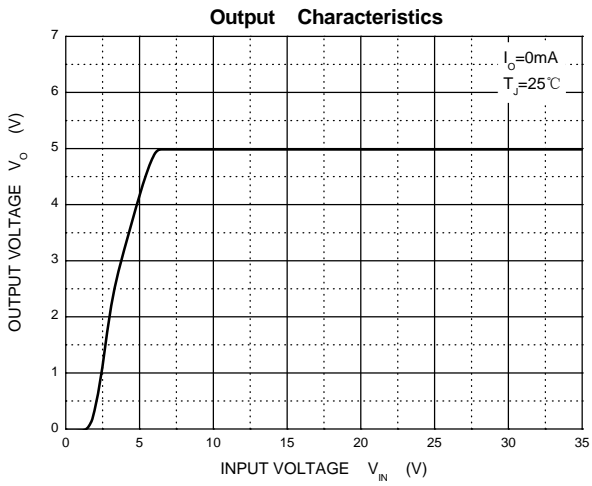

# TO-220-3L Package Outline Dimensions

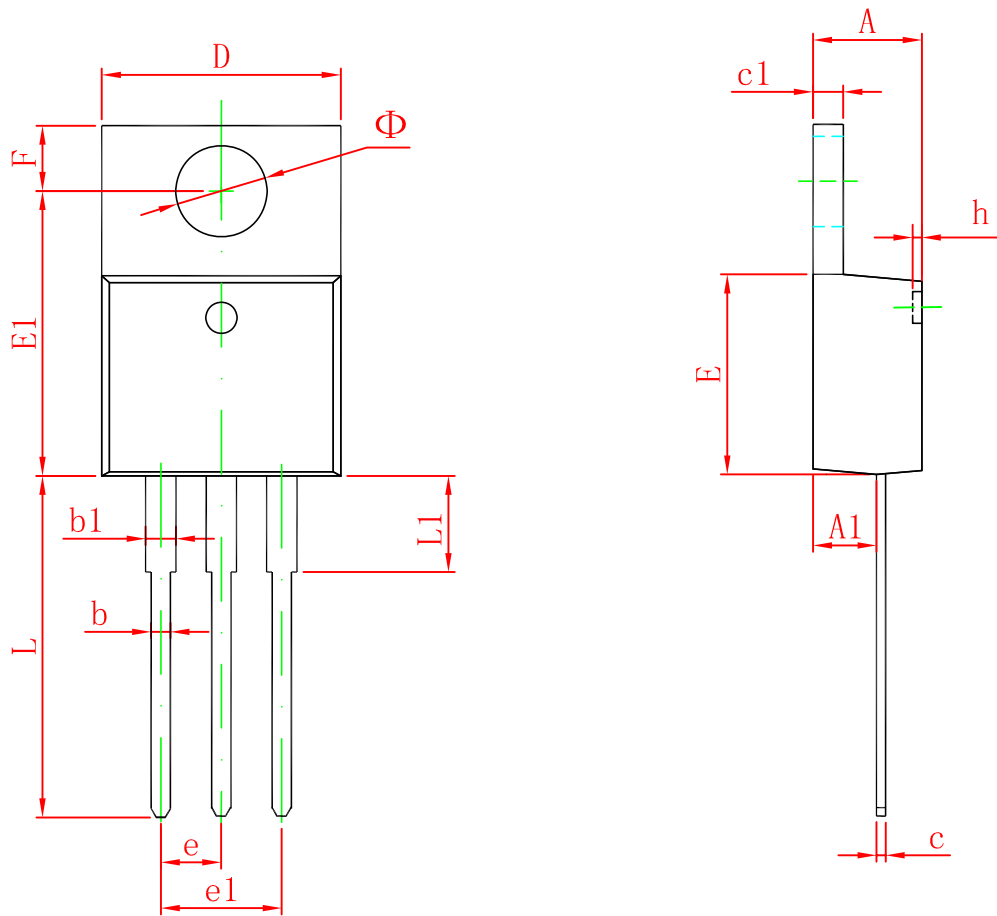

Symbol	Dimensions In Millimeters		Dimensions In Inches	
	Min	Max	Min	Max
A	4.470	4.670	0.176	0.184
A1	2.520	2.820	0.099	0.111
b	0.710	0.910	0.028	0.036
b1	1.170	1.370	0.046	0.054
c	0.310	0.530	0.012	0.021
c1	1.170	1.370	0.046	0.054
D	10.010	10.310	0.394	0.406
E	8.500	8.900	0.335	0.350
E1	12.060	12.460	0.475	0.491
e	2.540 TYP		0.100 TYP	
e1	4.980	5.180	0.196	0.204
F	2.590	2.890	0.102	0.114
h	0.000	0.300	0.000	0.012
L	13.400	13.800	0.528	0.543
L1	3.560	3.960	0.140	0.156
$\Phi$	3.735	3.935	0.147	0.155