

TO-220-3L Plastic-Encapsulate Voltage Regulators

CJ7808 Three-terminal positive voltage regulator

FEATURES

- Maximum output current
 $I_{OM}: 1.5\text{ A}$
- Output voltage
 $V_O: 8\text{ V}$
- Continuous total dissipation
 $P_D: 1.5\text{ W}$ ($T_a = 25\text{ }^\circ\text{C}$)

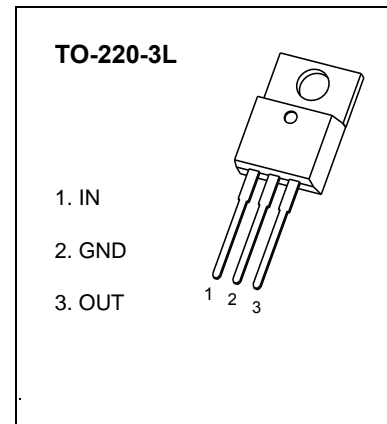

ABSOLUTE MAXIMUM RATINGS (Operating temperature range applies unless otherwise specified)

Parameter	Symbol	Value	Unit
Input Voltage	V_i	35	V
Thermal Resistance from Junction to Ambient	$R_{\theta JA}$	66.7	$^\circ\text{C/W}$
Operating Junction Temperature Range	T_{OPR}	-25~+125	$^\circ\text{C}$
Storage Temperature Range	T_{STG}	-65~+150	$^\circ\text{C}$

ELECTRICAL CHARACTERISTICS AT SPECIFIED VIRTUAL JUNCTION TEMPERATURE ($V_i=14\text{ V}$, $I_o=500\text{ mA}$, $C_i=0.33\mu\text{ F}$, $C_o=0.1\mu\text{ F}$, unless otherwise specified)

Parameter	Symbol	Test conditions	Min	Typ	Max	Unit
Output Voltage	V_o	$25\text{ }^\circ\text{C}$	7.7	8	8.3	V
		$10.5\text{ V} \leq V_i \leq 23\text{ V}$, $I_o=5\text{ mA}-1\text{ A}$	-25-125 $^\circ\text{C}$	7.6	8	8.4
Load Regulation	ΔV_o	$I_o=5\text{ mA}-1.5\text{ A}$	$25\text{ }^\circ\text{C}$	12	160	mV
		$I_o=250\text{ mA}-750\text{ mA}$	$25\text{ }^\circ\text{C}$	4	80	mV
Line Regulation	ΔV_o	$10.5\text{ V} \leq V_i \leq 25\text{ V}$	$25\text{ }^\circ\text{C}$	6	160	mV
		$11\text{ V} \leq V_i \leq 17\text{ V}$	$25\text{ }^\circ\text{C}$	2	80	mV
Quiescent Current	I_q	$25\text{ }^\circ\text{C}$		4.3	8	mA
Quiescent Current Change	ΔI_q	$10.5\text{ V} \leq V_i \leq 25\text{ V}$	-25-125 $^\circ\text{C}$		1	mA
		$5\text{ mA} \leq I_o \leq 1\text{ A}$	-25-125 $^\circ\text{C}$		0.5	mA
Output Voltage Drift	$\Delta V_o/\Delta T$	$I_o=5\text{ mA}$	-25-125 $^\circ\text{C}$	-0.8		mV/ $^\circ\text{C}$
Output Noise Voltage	V_N	$10\text{ Hz} \leq f \leq 100\text{ KHz}$	$25\text{ }^\circ\text{C}$	52		$\mu\text{ V}/V_o$
Ripple Rejection	RR	$11.5\text{ V} \leq V_i \leq 21.5\text{ V}$, $f=120\text{ Hz}$	-25-125 $^\circ\text{C}$	55	72	dB
Dropout Voltage	V_d	$I_o=1\text{ A}$	$25\text{ }^\circ\text{C}$	2		V
Output Resistance	R_o	$f=1\text{ KHz}$	$25\text{ }^\circ\text{C}$	10		m Ω
Short Circuit Current	I_{sc}		$25\text{ }^\circ\text{C}$	450		mA
Peak Current	I_{pk}		$25\text{ }^\circ\text{C}$	2.2		A

* Pulse test.

TYPICAL APPLICATION

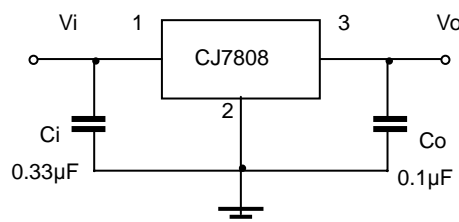

Note: Bypass capacitors are recommended for optimum stability and transient response and should be located as close as possible to the regulators.

Typical Characteristics

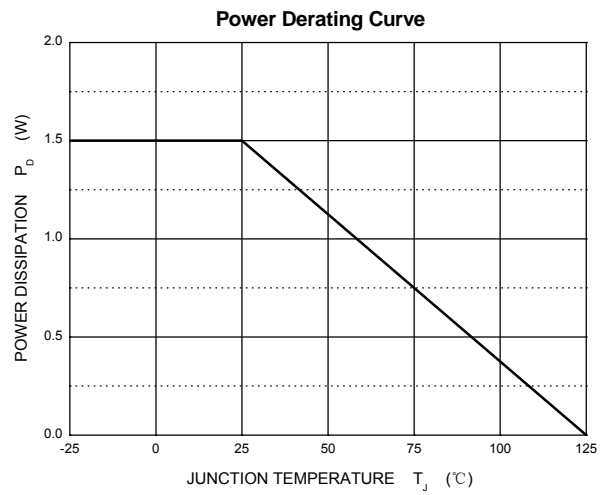
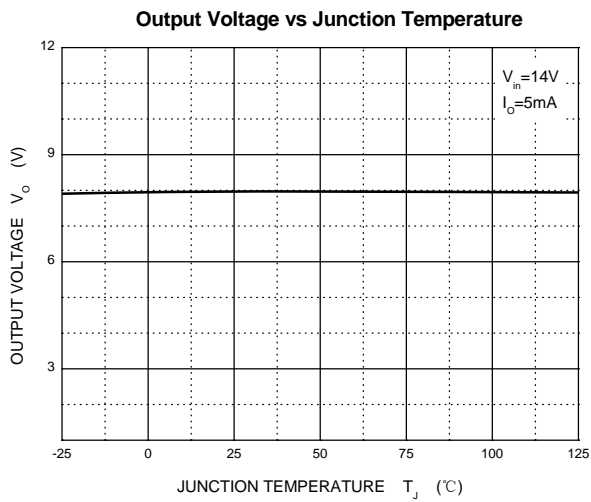
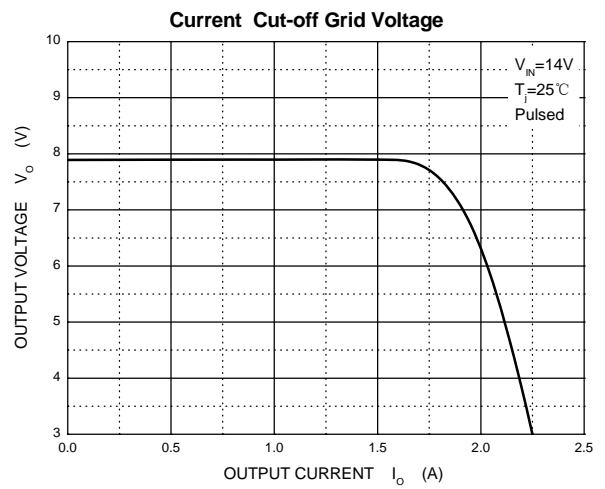
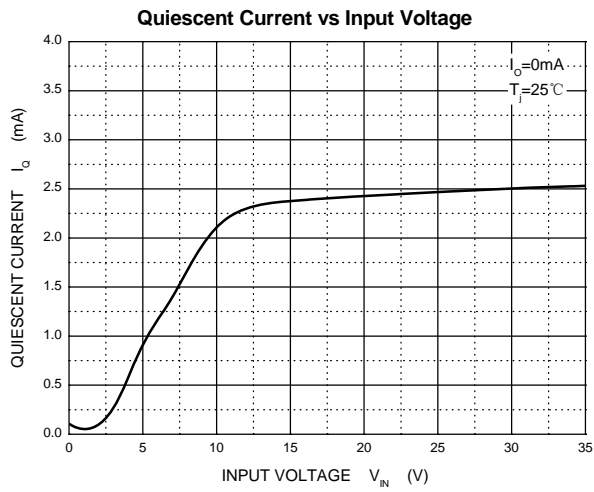
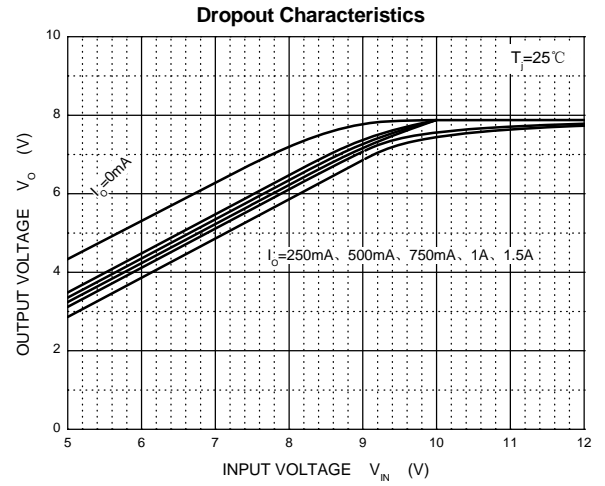
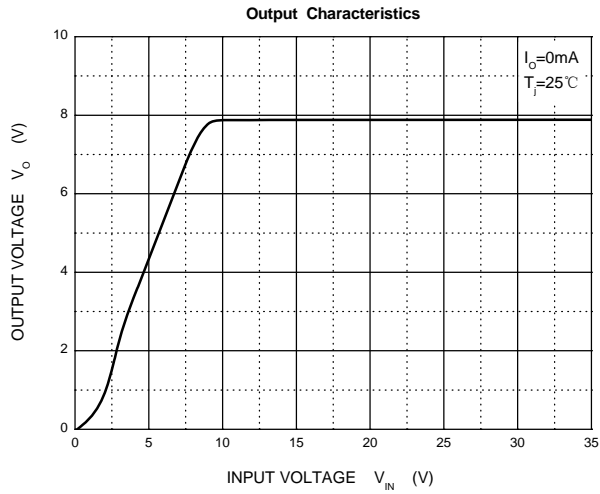

TO-220-3L Package Outline Dimensions

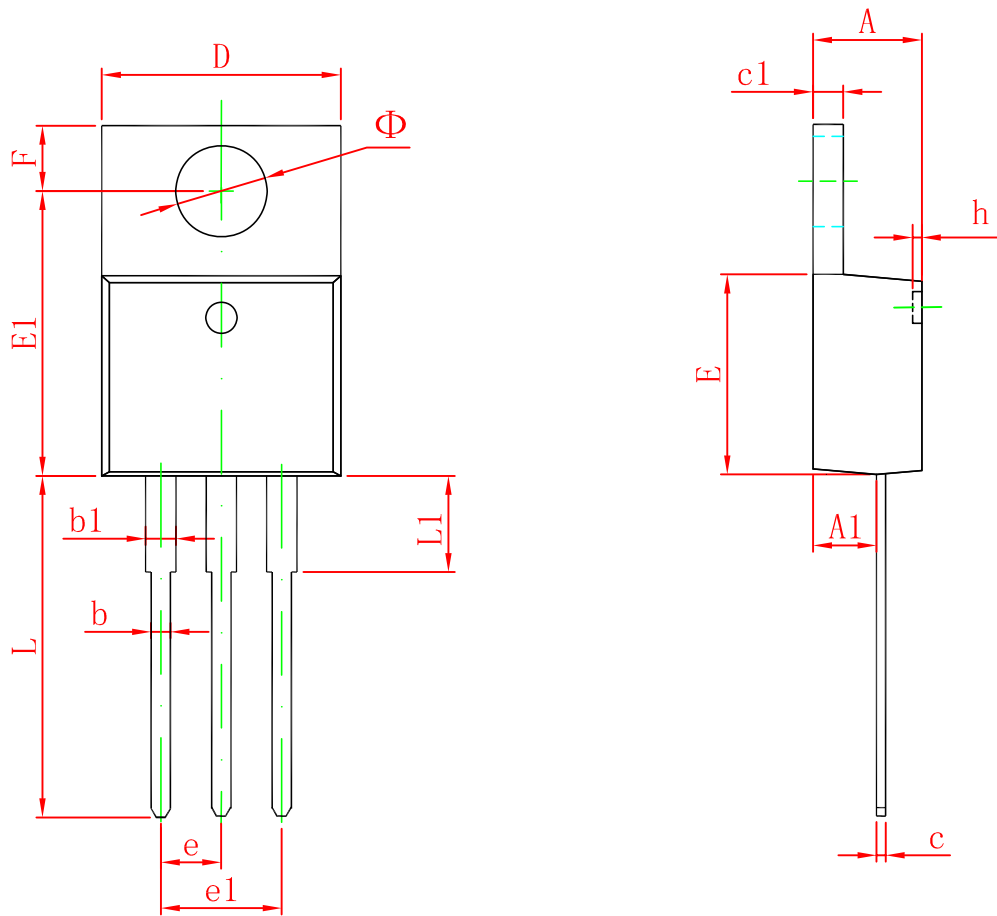

Symbol	Dimensions In Millimeters		Dimensions In Inches	
	Min	Max	Min	Max
A	4.470	4.670	0.176	0.184
A1	2.520	2.820	0.099	0.111
b	0.710	0.910	0.028	0.036
b1	1.170	1.370	0.046	0.054
c	0.310	0.530	0.012	0.021
c1	1.170	1.370	0.046	0.054
D	10.010	10.310	0.394	0.406
E	8.500	8.900	0.335	0.350
E1	12.060	12.460	0.475	0.491
e	2.540 TYP		0.100 TYP	
e1	4.980	5.180	0.196	0.204
F	2.590	2.890	0.102	0.114
h	0.000	0.300	0.000	0.012
L	13.400	13.800	0.528	0.543
L1	3.560	3.960	0.140	0.156
Φ	3.735	3.935	0.147	0.155