



SOT-323 Plastic-Encapsulate Transistors

BC807W TRANSISTOR (PNP)

FEATURES

- Ideally suited for automatic insertion
- Epitaxial planar die construction
- Complementary to BC817W

MAXIMUM RATINGS (T_a=25°C unless otherwise noted)

Symbol	Parameter	Value	Unit
V _{CBO}	Collector-Base Voltage	-50	V
V _{CEO}	Collector-Emitter Voltage	-45	V
V _{EBO}	Emitter-Base Voltage	-5	V
I _C	Collector Current -Continuous	-0.5	A
P _C	Collector Power Dissipation	0.2	W
R _{θJA}	Thermal Resistance from Junction to Ambient	6℃	°C/W
T _J	Junction Temperature	150	°C
T _{stg}	Storage Temperature	-55~+150	°C

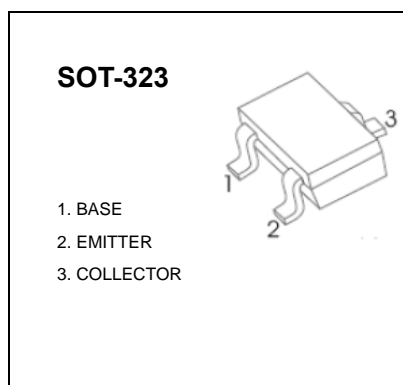

ELECTRICAL CHARACTERISTICS (T_a=25°C unless otherwise specified)

Parameter	Symbol	Test conditions	Min	Max	Unit
Collector-base breakdown voltage	V _{CBO}	I _C =-10μA, I _E =0	-50		V
Collector-emitter breakdown voltage	V _{CEO}	I _C =-10mA, I _B =0	-45		V
Emitter-base breakdown voltage	V _{EBO}	I _E =-1μA, I _C =0	-5		V
Collector cut-off current	I _{CBO}	V _{CB} =-20 V, I _E =0		-0.1	μA
Emitter cut-off current	I _{EBO}	V _{EB} =-5 V, I _C =0		-0.1	μA
DC current gain	h _{FE(1)}	V _{CE} =-1V, I _C = -100mA	100	600	
	h _{FE(2)}	V _{CE} =-1V, I _C = -500mA	40		
Collector-emitter saturation voltage	V _{CE(sat)}	I _C =-500mA, I _B =-50 mA		-0.7	V
Base-emitter voltage	V _{BE(on)}	V _{CE} = -1V, I _C = -500mA		-1.2	V
Transition frequency	f _T	V _{CE} =-5 V, I _C = -10mA f=100MHz	80		MHz
Collector output capacitance	C _{ob}	V _{CB} =-10V, f=1MHz		10	pF

CLASSIFICATION of h_{FE} (1)

Rank	BC807-16W	BC807-25W	BC807-40W
Range	100-250	160-400	250-600
Marking	5A	5B	5C

Typical Characteristics

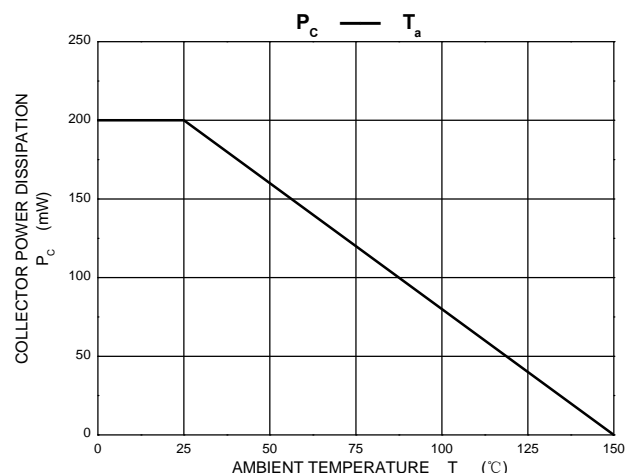
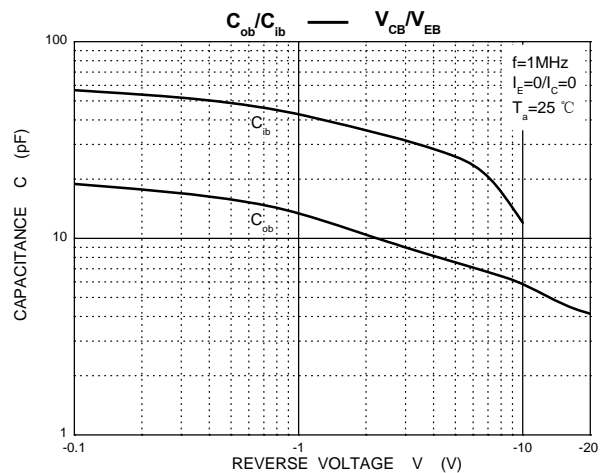
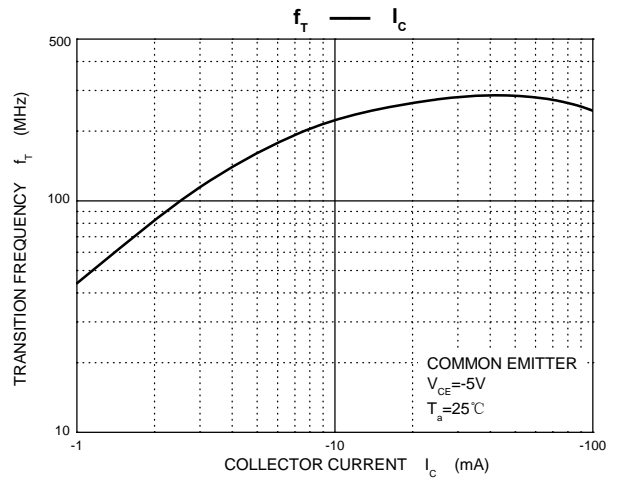
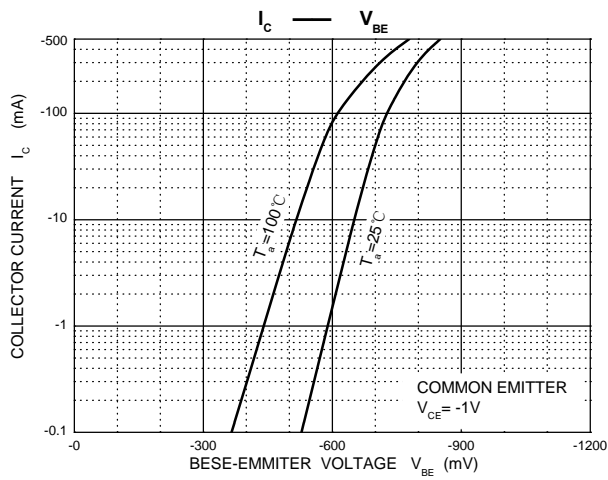
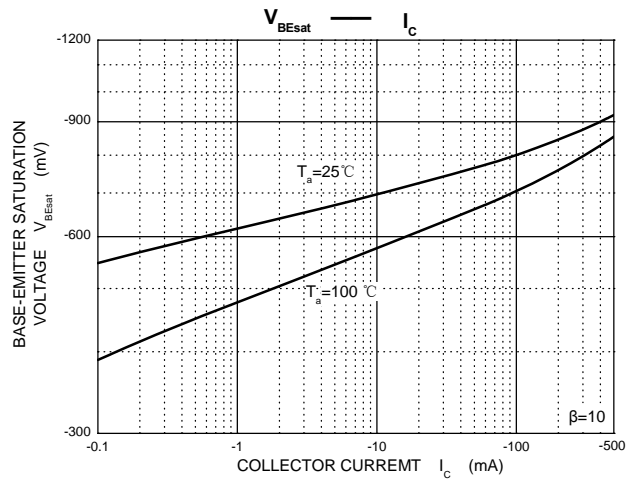
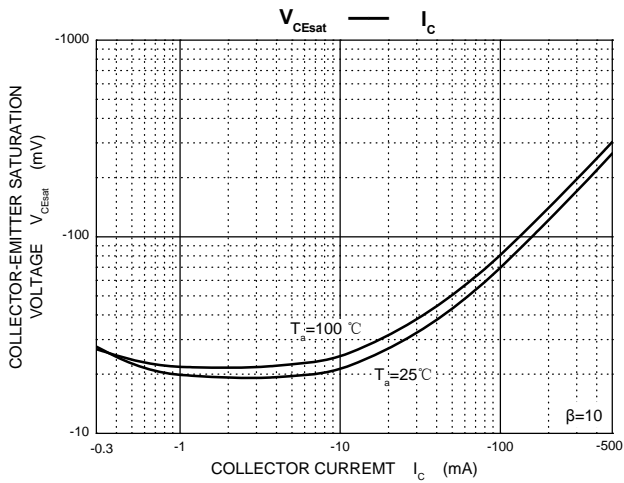
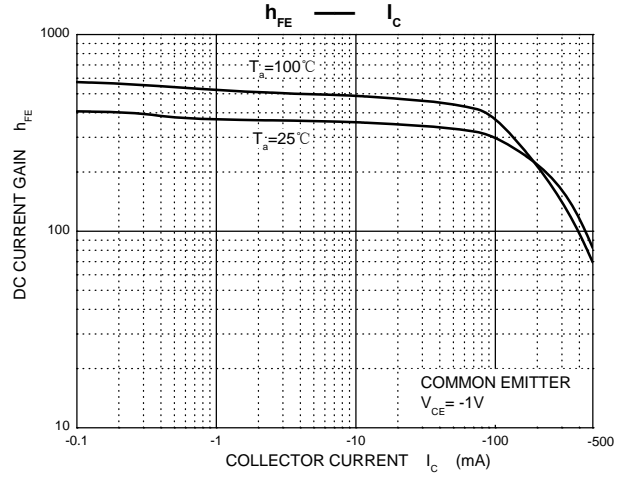
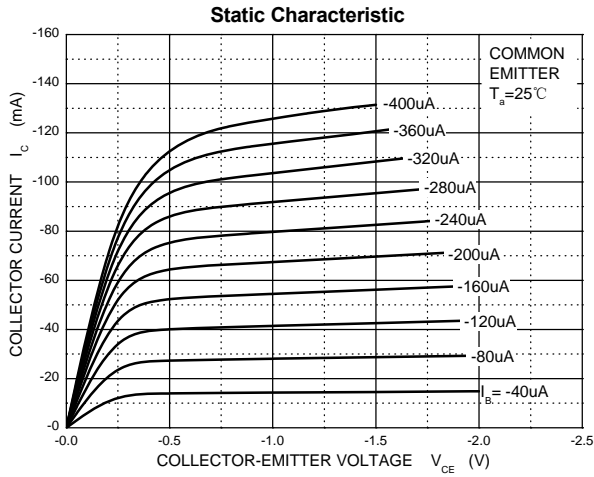

SOT-323 Package Outline Dimensions

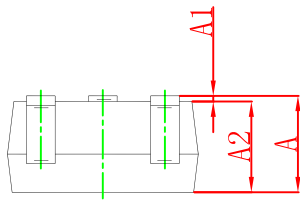
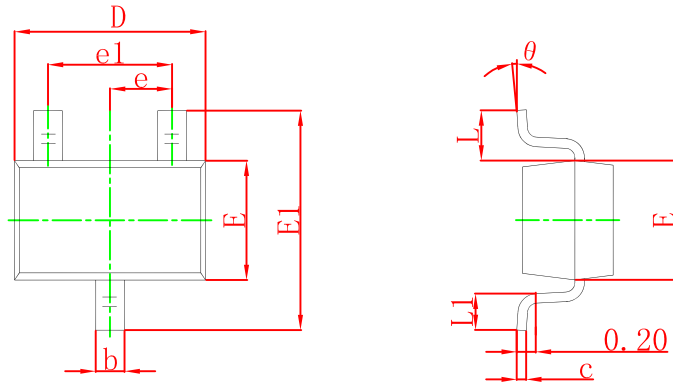

Symbol	Dimensions In Millimeters		Dimensions In Inches	
	Min	Max	Min	Max
A	0.900	1.100	0.035	0.043
A1	0.000	0.100	0.000	0.004
A2	0.900	1.000	0.035	0.039
b	0.200	0.400	0.008	0.016
c	0.080	0.150	0.003	0.006
D	2.000	2.200	0.079	0.087
E	1.150	1.350	0.045	0.053
E1	2.150	2.450	0.085	0.096
e	0.650 TYP		0.026 TYP	
e1	1.200	1.400	0.047	0.055
L	0.525 REF		0.021 REF	
L1	0.260	0.460	0.010	0.018
θ	0°	8°	0°	8°

SOT-323 Suggested Pad Layout

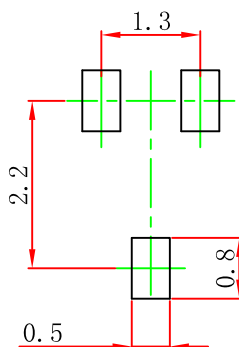

Note:

1. Controlling dimension: in millimeters.
2. General tolerance: ± 0.05 mm.
3. The pad layout is for reference purposes only.

NOTICE

JCET reserve the right to make modifications, enhancements, improvements, corrections or other changes without further notice to any product herein. JCET does not assume any liability arising out of the application or use of any product described herein.

SOT-323 Tape and Reel

SOT-323 Embossed Carrier Tape

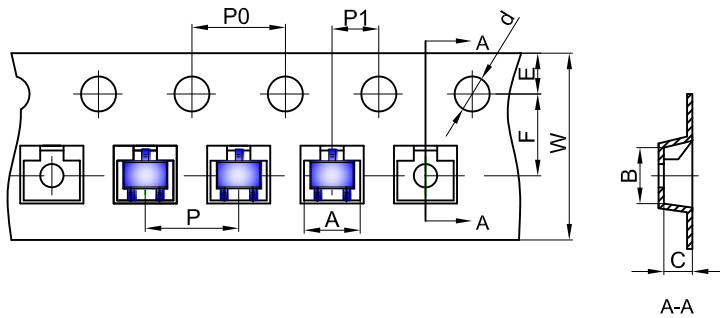

Packaging Description:
 SOT-323 parts are shipped in tape. The carrier tape is made from a dissipative (carbon filled) polycarbonate resin. The cover tape is a multilayer film (Heat Activated Adhesive in nature) primarily composed of polyester film, adhesive layer, sealant, and anti-static sprayed agent. These reeled parts in standard option are shipped with 3,000 units per 7" or 17.8cm diameter reel. The reels are clear in color and is made of polystyrene plastic (anti-static coated).

Dimensions are in millimeter										
Pkg type	A	B	C	d	E	F	P0	P	P1	W
SOT-323	2.25	2.55	1.19	Ø1.55	1.75	3.50	4.00	4.00	2.00	8.00

SOT-323 Tape Leader and Trailer

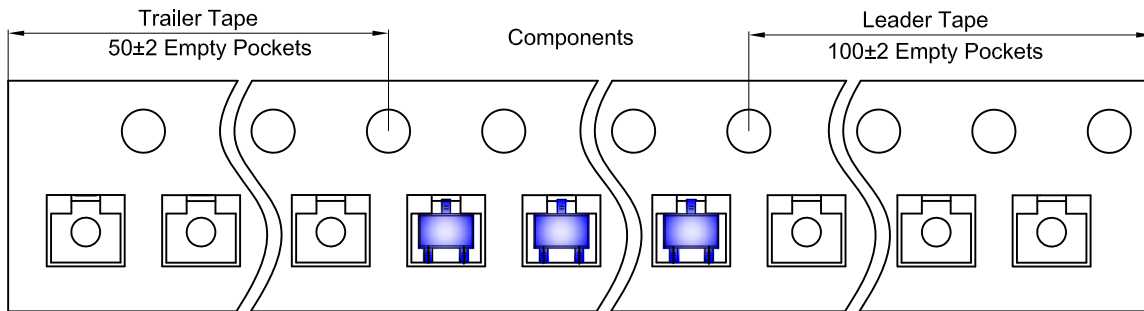

SOT-323 Reel

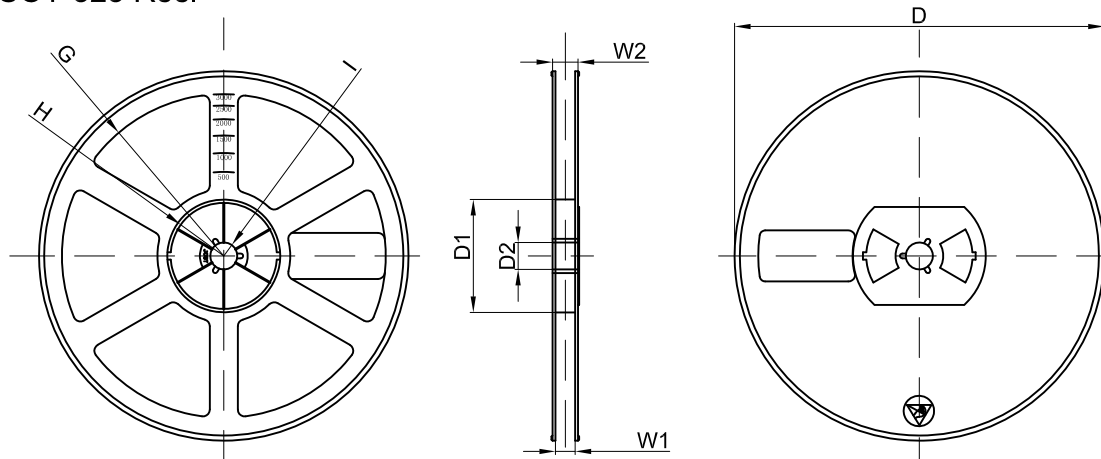

Dimensions are in millimeter								
Reel Option	D	D1	D2	G	H	I	W1	W2
7" Dia	Ø178.00	54.40	13.00	R78.00	R25.60	R6.50	9.50	12.30

REEL	Reel Size	Box	Box Size(mm)	Carton	Carton Size(mm)	G.W.(kg)
3000 pcs	7 inch	45,000 pcs	203×203×195	180,000 pcs	438×438×220	