

# 7808

## 3-terminal 1 A positive voltage regulator

### Features

- Output Current up to 1 A
- Thermal Overload Protection
- Short Circuit Protection
- Output Transistor Safe Operating Area Protection

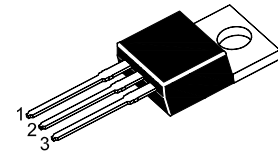

1.Input 2.Common 3.Output  
TO-220 Plastic Package

### Absolute Maximum Ratings ( $T_a = 25^\circ\text{C}$ )

Parameter	Symbol	Value	Units
Input Voltage	$V_I$	35	V
Thermal Resistance Junction-Cases	$R_{\theta JC}$	5	$^\circ\text{C/W}$
Thermal Resistance Junction-Air	$R_{\theta JA}$	65	$^\circ\text{C/W}$
Operating Temperature Range	$T_{OPR}$	0 to +125	$^\circ\text{C}$
Storage Temperature Range	$T_S$	-65 to +150	$^\circ\text{C}$

### Electrical Characteristics

( $0^\circ\text{C} < T_J < 125^\circ\text{C}$ ,  $I_O = 500\text{ mA}$ ,  $V_I = 14\text{ V}$ ,  $C_I = 0.33\ \mu\text{F}$ ,  $C_O = 0.1\ \mu\text{F}$ , unless otherwise specified)

Parameter	Symbol	Conditions	Min.	Typ.	Max.	Unit	
Output Voltage	$V_O$	$T_J = +25^\circ\text{C}$	7.7	8	8.3	V	
		$5\text{ mA} \leq I_O \leq 1\text{ A}$ , $P_O \leq 15\text{ W}$ $V_I = 10.5\text{ V to } 23\text{ V}$	7.6	8	8.4		
Line Regulation <sup>1)</sup>	Regline	$T_J = +25^\circ\text{C}$	$V_I = 10.5\text{ V to } 25\text{ V}$	-	-	160	mV
			$V_I = 11.5\text{ V to } 17\text{ V}$	-	-	80	
Load Regulation <sup>1)</sup>	Regload	$T_J = +25^\circ\text{C}$	$I_O = 5\text{ mA to } 1.5\text{ A}$	-	-	160	mV
			$I_O = 250\text{ mA to } 750\text{ mA}$	-	-	80	
Quiescent Current	$I_Q$	$T_J = +25^\circ\text{C}$	-	-	8	mA	
Quiescent Current Change	$\Delta I_Q$	$I_O = 5\text{ mA to } 1\text{ A}$	-	-	0.5	mA	
		$V_I = 10.5\text{ V to } 25\text{ V}$	-	-	1		
Output Voltage Drift	$\Delta V_O / \Delta T$	$I_O = 5\text{ mA}$	-	-0.8	-	$\text{mV}/^\circ\text{C}$	
Output Noise Voltage	$V_N$	$f = 10\text{ Hz to } 100\text{ KHz}$ , $T_A = +25^\circ\text{C}$	-	52	-	$\mu\text{V}$	
Ripple Rejection	RR	$f = 120\text{ Hz}$ , $V_I = 11.5\text{ V to } 21.5\text{ V}$	56	-	-	dB	
Dropout Voltage	$V_{Drop}$	$I_O = 1\text{ A}$ , $T_J = +25^\circ\text{C}$	-	2	-	V	
Output Resistance	$R_O$	$f = 1\text{ KHz}$	-	17	-	$\text{m}\Omega$	
Short Circuit Current	$I_{SC}$	$V_I = 35\text{ V}$ , $T_A = +25^\circ\text{C}$	-	230	-	mA	
Peak Current	$I_{PK}$	$T_J = +25^\circ\text{C}$	-	2.2	-	A	

<sup>1)</sup> Load and line regulation are specified at constant junction temperature, Changes in  $V_O$  due to heating effects must be taken into account separately, Pulse testing with low duty is used.

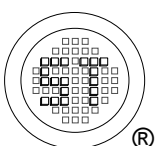

**SEMTECH ELECTRONICS LTD.**



Typical Performance Characteristics

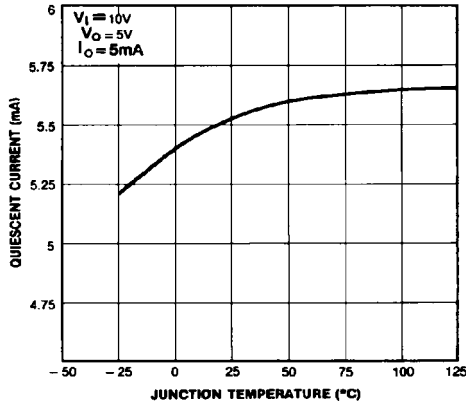

Figure 1. Quiescent Current

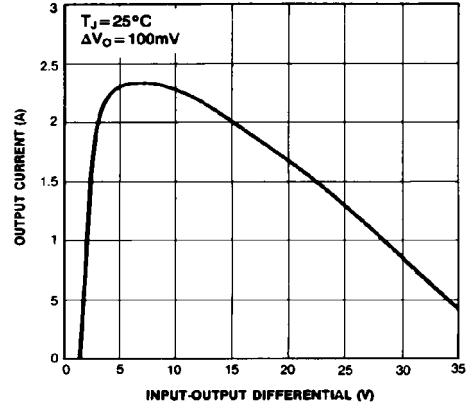

Figure 2. Peak Output Current

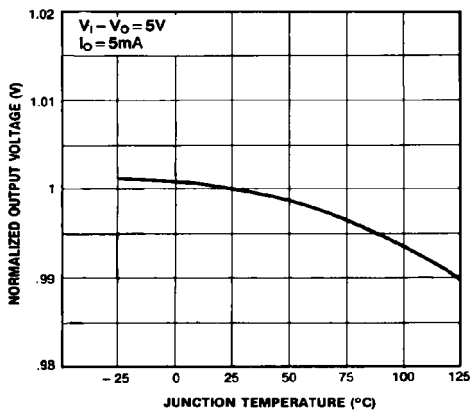

Figure 3. Output Voltage

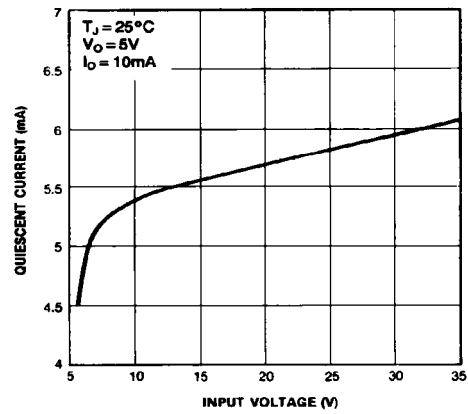
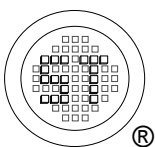

Figure 4. Quiescent Current



**SEMTECH ELECTRONICS LTD.**



TO-220 PACKAGE OUTLINE

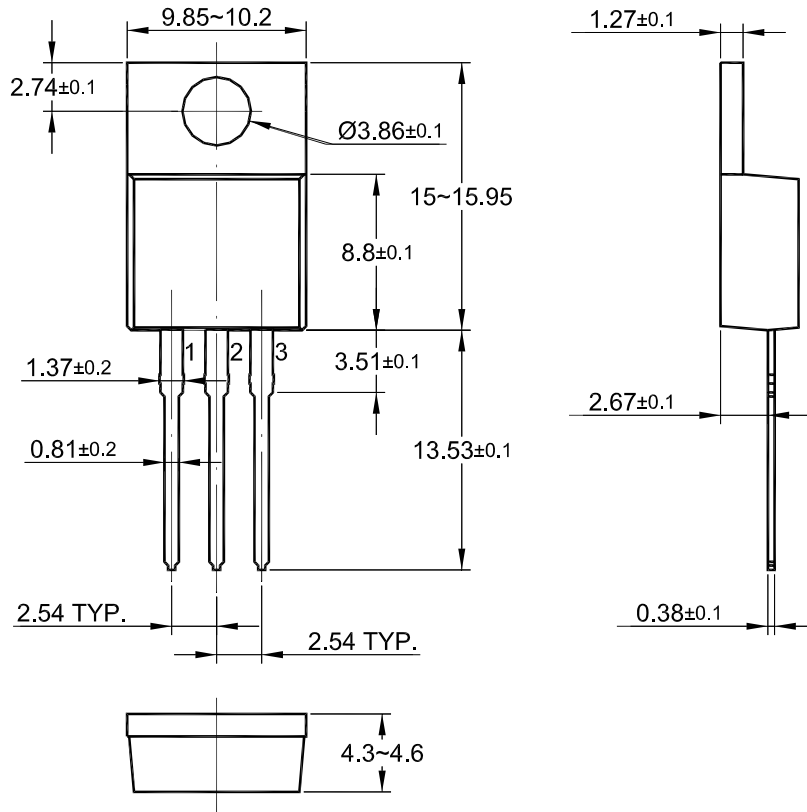

Dimensions in mm

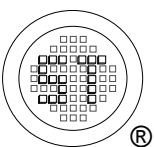

**SEMTECH ELECTRONICS LTD.**

