

2SC4541U

NPN Silicon Epitaxial Planar Transistor

for power switching and power amplifier applications

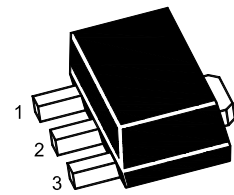

1.Base 2.Collector 3.Emitter
SOT-89 Plastic Package

Absolute Maximum Ratings ($T_a = 25^\circ\text{C}$)

Parameter	Symbol	Value	Unit
Collector Base Voltage	V_{CB0}	80	V
Collector Emitter Voltage	V_{CEO}	50	V
Emitter Base Voltage	V_{EBO}	6	V
Collector Current	I_C	3	A
Base Current	I_B	0.6	A
Total Power Dissipation	P_{tot}	0.5 1 ¹⁾	W
Junction Temperature	T_j	150	$^\circ\text{C}$
Storage Temperature Range	T_{stg}	- 55 to + 150	$^\circ\text{C}$

¹⁾ mounted on a ceramic substrate (250 mm² x 0.8 t)

Characteristics at $T_a = 25^\circ\text{C}$

Parameter	Symbol	Min.	Typ.	Max.	Unit
DC Current Gain at $V_{CE} = 2\text{ V}$, $I_C = 100\text{ mA}$ at $V_{CE} = 2\text{ V}$, $I_C = 2\text{ A}$	h_{FE} h_{FE}	120 40	- -	400 -	- -
Collector Base Cutoff Current at $V_{CB} = 80\text{ V}$	I_{CBO}	-	-	0.1	μA
Emitter Base Cutoff Current at $V_{EB} = 6\text{ V}$	I_{EBO}	-	-	0.1	μA
Collector Emitter Breakdown Voltage at $I_C = 10\text{ mA}$	$V_{(BR)CEO}$	50	-	-	V
Collector Emitter Saturation Voltage at $I_C = 1.5\text{ A}$, $I_B = 75\text{ mA}$	$V_{CE(sat)}$	-	-	0.5	V
Base Emitter Saturation Voltage at $I_C = 1.5\text{ A}$, $I_B = 75\text{ mA}$	$V_{BE(sat)}$	-	-	1.2	V
Transition Frequency at $V_{CE} = 2\text{ V}$, $I_C = 100\text{ mA}$	f_T	-	100	-	MHz
Collector Output Capacitance at $V_{CB} = 10\text{ V}$, $f = 1\text{ MHz}$	C_{ob}	-	20	-	pF
Turn-on Time at $V_{CC} = 30\text{ V}$, $I_C = 1.5\text{ A}$, $I_{B1} = -I_{B2} = 75\text{ mA}$	t_{on}	-	100	-	ns
Storage Time at $V_{CC} = 30\text{ V}$, $I_C = 1.5\text{ A}$, $I_{B1} = -I_{B2} = 75\text{ mA}$	t_{stg}	-	500	-	ns
Fall Time at $V_{CC} = 30\text{ V}$, $I_C = 1.5\text{ A}$, $I_{B1} = -I_{B2} = 75\text{ mA}$	t_f	-	100	-	ns

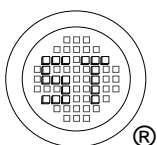

SEMTECH ELECTRONICS LTD.



ISO/TS 16949 : 2009 Certificate No. 180713000
ISO14001 : 2004 Certificate No. 7116
ISO 9001 : 2008 Certificate No. 90719410
BS-OHSAS 18001 : 2007 Certificate No. 7116
IECQ QC 080000 Certificate No. PRC:SPM-1483

Dated: 24/02/2016 Rev: 03

2SC4541U

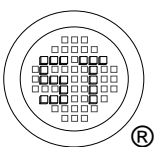
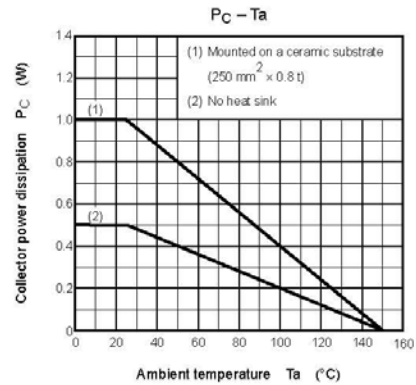
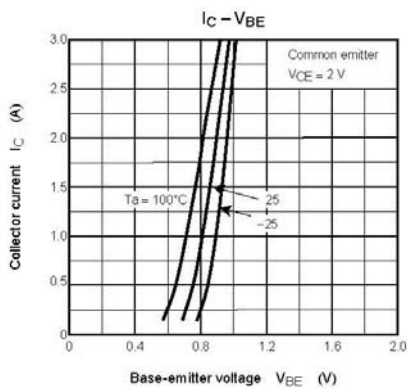
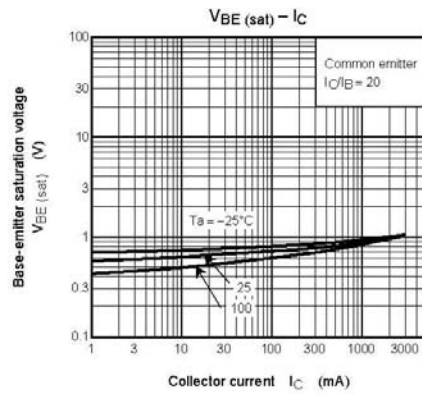
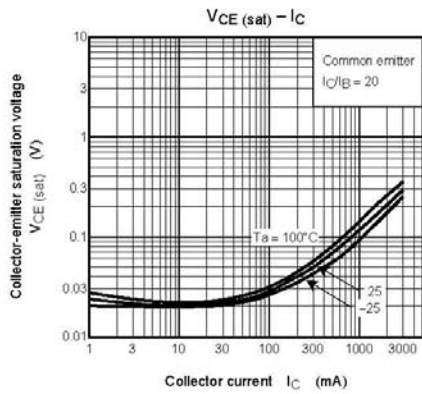
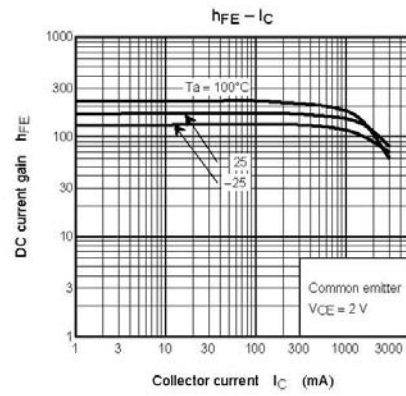
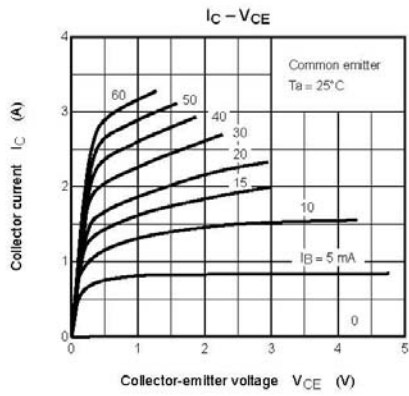

SEMTECH ELECTRONICS LTD.



ISO/TS 16949 : 2009
Certificate No. 180713000



ISO14001 : 2004
Certificate No. 7116



ISO 9001 : 2008
Certificate No. 50713410



BS-OHSAS 18001 : 2007
Certificate No. 7116



IECQ QC 080000
Certificate No. PRC18P0414831

2SC4541U

SOT-89 PACKAGE OUTLINE

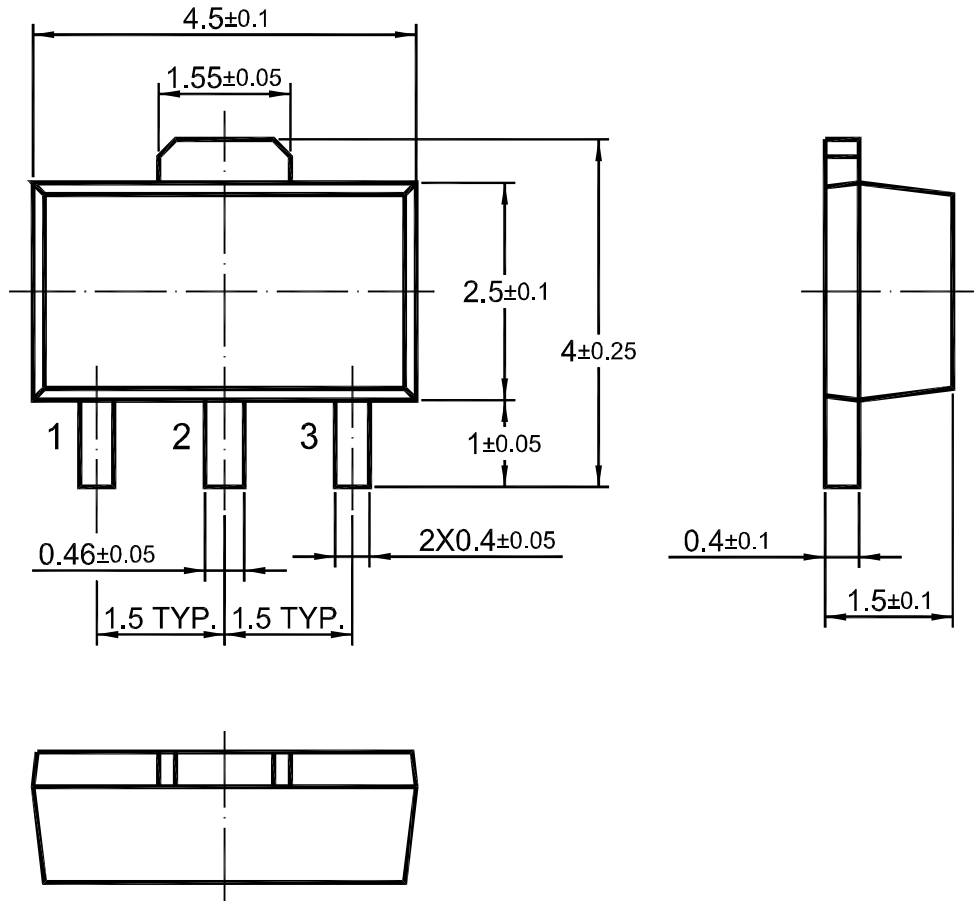

Dimensions in mm

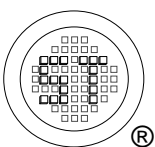

SEMTECH ELECTRONICS LTD.



Dated: 24/02/2016 Rev: 03